



**Models 545B & 548B
CW Microwave
Frequency Counters
Operation Manual**

545B CCN 2219
548B CCN 2319

Manual Assy Part Number: 5585048-07
Manual Text Part Number: 5580057-06
Printed in USA, March 1996

Warranty

Phase Matrix, Inc. warrants this product to be free from defects in material and workmanship for one year from the date of delivery. Damage due to accident, abuse, or improper signal level is not covered by the warranty. Removal, defacement, or alteration of any serial or inspection label, marking or seal may void the warranty. Phase Matrix, Inc. will repair or replace, at its option, any components of this product which prove to be defective during the warranty period, provided the entire unit is returned COLLECT to Phase Matrix, Inc. or an authorized repair facility. Please visit our web site at: www.phasematrix.com for up-to-date return information. In warranty units will be returned freight prepaid; out of warranty units will be returned freight COLLECT. No other warranty other than above is expressed or implied.

Certification

Phase Matrix, Inc. certifies this instrument to be in conformance with the specifications noted herein at time of shipment from the factory. Phase Matrix, Inc. further certifies that its calibration measurements are traceable to the National Institute of Standards and Technology (NIST).

Manual Change Information

As Phase Matrix, Inc. continually improves and updates its products, changes to the material covered by the manual will occur. When a part or assembly in a Phase Matrix, Inc. instrument is change to the extent that it is no longer interchangeable with the earlier part, the configuration control number (CCN) of the instrument, shown on the title page of the manual, will change, and a new edition of the manual will be published.

To maintain the technical accuracy of the manual, it may be necessary to provide new or additional information with the manual. In these cases, the manual is shipped with a Manual update. Please be sure to incorporate the information as instructed in the Manual update.

SAFETY

The Phase Matrix, Inc. Models 545B/548B are designed and tested according to international safety requirements, but as with all electronic equipment, certain precautions must be observed. This manual contains information, cautions, and warnings that must be followed to prevent the possibility of personal injury and/or damage to the instrument.

SAFETY AND HAZARD SYMBOLS

WARNING

A WARNING denotes a hazard to personnel. It calls attention to a procedure or practice, which, if not correctly performed or adhered to, could result in personal injury.

CAUTION

A CAUTION denotes a hazard to the equipment. It calls attention to an operating procedure or practice, which, if not correctly performed or adhered to, could result in damage to or destruction of part or all of the product.



This is a general warning that appears whenever care is necessary to prevent damage to the equipment.



Dangerous Voltage



Toxic Substance



Static-Sensitive Component



Fire Hazard

OVERALL SAFETY CONSIDERATIONS**WARNING**

Before this instrument is switched on, its protective earth terminals *must* be connected to the AC power cord's protective conductor. The main plug *must* only be inserted in a socket/outlet that has a protective earth contact. The protective action must not be negated by using an extension cord (power cable) or adapter that does not have a protective earth (grounding) conductor.

**WARNING**

Use only fuses of the type specified with the required current and voltage ratings. Never use repaired fuses or short-circuited fuse holders, as doing so causes shock and/or fire hazard.

**WARNING**

Whenever it is likely that electrical protection is impaired, the instrument *must* be made inoperative and be secured against any unintended operation.

**WARNING**

All protective earth terminals, extension cords, autotransformers, and other devices connected to this instrument *must* be connected to a socket/outlet that has a protective earth contact. Any interruption of the protection causes a potential shock hazard that can result in personal injury.

**WARNING**

The power supply is energized whenever AC power is connected to this instrument. Disconnect the AC power cord before removing the covers to prevent electrical shock. Internal adjustments or servicing that must be done with the AC power cord connected must be performed only by qualified personnel.



WARNING _____
Since the power supply filter capacitors may remain charged after the AC power cord is disconnected from the equipment, disconnecting the power cord does not ensure that there is no electrical shock hazard.



WARNING _____
Some of the components used in this instrument contain resins and other chemicals that give off toxic fumes if burned. Be sure to dispose of these items properly.



WARNING _____
Beryllia (beryllium oxide) is used in the construction of the YTF assembly. This material, if handled incorrectly, can pose a health hazard. *NEVER* disassemble the microwave counter assembly.



CAUTION _____
Static sensitive components are used in the YTF Assembly. These components can be damaged if handled incorrectly.



CAUTION _____
Before connecting power to the instrument, ensure that the correct fuse is installed and the voltage-selection switch on the instrument's rear panel is set properly. Refer to INSTALLATION Section 2, *Installation*.



CAUTION _____
Excessive signal levels can damage this instrument. To prevent damage, do not exceed the specified damage level. Refer to the instrument specifications in Section 1 of this manual.

TABLE OF CONTENTS

Warranty iii
 Certification iii
 Manual Change Information iii
 Customer Suggestion Form iii
 Safety iv
 List of Illustrations xi

**SECTION 1
 GENERAL INFORMATION**

Description 1-1
 Operating Conditions 1-1
 Ventilation 1-2
 Storage 1-2
 Options And Accessories 1-2
 Specifications 1-3
 Declaration of Conformity 1-8

**SECTION 2
 INSTALLATION**

Unpacking 2-1
 Installation 2-1
 Voltage Selection 2-2
 Fuse Replacement 2-2
 Incoming Operational Check 2-2
 Service Information 2-3
 Periodic Maintenance 2-3
 Counter Identification 2-3
 Factory Service 2-3
 Shipping Instructions 2-3

**SECTION 3
 OPERATION**

Introduction 3-1
 Front Panel Controls, Connectors, And Indicators 3-1
 Status Display 3-2
 Signal Input 3-3
 Rear Panel Controls And Connectors 3-4
 Instrument Default Settings 3-4



TABLE OF CONTENTS (Continued)

SECTION 3
OPERATION (Continued)

Keyboard	3-5
RESET/LOCAL	3-5
UNITS (MHz/GHz)	3-5
CLEAR DATA/CLEAR DISPLAY	3-5
Counter Control Functions	3-6
Band Selection	3-6
Resolution/Gate Time Selection	3-7
0.1 Hz Resolution	3-7
Frequency Limits	3-8
To Input Frequency Limits	3-8
To Display Stored Limits	3-8
To Clear Frequency Limits	3-9
Data Manipulation Functions	
Frequency Offset	3-9
To Input Frequency Offsets	3-9
To Display Stored Offset	3-10
To Clear Frequency Offsets	3-10
Multiply Function	3-10
To Enter Multiplier	3-10
To Display Multiplier	3-11
To Clear Multiplier	3-11
mX±B	3-11
DAC	3-11
Description	3-11
Keyboard Operation	3-12
Power Meter	3-12
Description	3-12
Keyboard Operation	3-12
Test Selections	3-13
Power-on Tests	3-13
Test Functions	3-13
Test 01 — 200 MHz Self-Test	3-13
Test 02 — Light Display Segments Test	3-14
Test 03 — Scan Display Segments Test	3-14
Test 04 — Scan Display Digits Test	3-14
Test 05 — Keyboard Test	3-14

TABLE OF CONTENTS (Continued)

SECTION 3
OPERATION (Continued)

Test 06 — Converter Ramp Test	3-15
Test 07 — Sweep VCO Test	3-15
Test 08 — Power Meter Offset Test	3-15
Test 09 — Power Meter Gain Test	3-15
Test 10 — Memory Read/Alter Routine	3-16
Test 90 — Display and/or Alter GPIB Address	3-16
Test 91 — YIG DAC Automatic Calibration	3-16
To Exit Tests	3-16
Mutually Exclusive Functions	3-17
Signal Measurements with the 545B/548B	3-17
Automatic Frequency Measurements	3-17
Multiple Signal Measurements	3-17
Options	3-18
Millimeter-wave Measurements	3-18
Error Messages	3-19
Operator Errors	3-19
Counter Errors	3-19

SECTION 4
PROGRAMMING

GPIB Functions Implemented	4-1
Remote/Local Function	4-1
Device Clear Function	4-2
Device Trigger Function	4-2
GPIB Address Selection	4-2
Talk Only Modes	4-2
GPIB Instruction Format	4-3
Formal Definition Of Instructions	4-4
Program Code Set	4-4
Display	4-4
Band	4-4
Resolution	4-4
Measurement Functions	4-5
Data Manipulation Functions	4-5
Power Meter	4-5
Frequency Limits	4-6



TABLE OF CONTENTS (Continued)

SECTION 4
PROGRAMMING (Continued)

Self-Test Function 4-6

Data Format 4-6

Data Output 4-6

Service Request 4-6

DAC Option 4-6

Description Of Available Commands 4-6

 Display 4-6

 Band 4-7

 Resolution 4-7

 Measurement Functions 4-7

 Data Manipulation Functions 4-7

 Power Meter 4-8

 Frequency Limits 4-8

 Self-Test Functions 4-8

 Data Format 4-8

 Data Output 4-8

 DAC Option 4-9

 Service Request 4-9

Service Request Mask 4-9

Data Output Format 4-11

Program Examples 4-12

Reading a Measurement 4-13

Input Speed 4-13

SECTION 5
OPERATIONAL VERIFICATION TESTS

Introduction 5-1

Equipment Requirements 5-1

Source Locking Setup 5-2

Operational Verification Test Procedures

 Band 1 Range And Sensitivity Test (10 Hz To 10 Mhz) 5-3

 Band 1 Range And Sensitivity Test (20 Mhz To 100 Mhz) 5-4

 Band 2 Range And Sensitivity Test 5-5

 Band 3 Range And Sensitivity Test 5-6

 Band 3 Amplitude Discrimination Test 5-7

 Band 4 Subband 1 Range And Sensitivity Test (548B Option 06 Only) 5-8

TABLE OF CONTENTS (Continued)

SECTION 5 OPERATIONAL VERIFICATION TESTS

Operational Test Record	5-9
-----------------------------------	-----

LIST OF ILLUSTRATIONS

Figure	Page
1-1 Option 10, Chassis Slides	1-7
2-1 Rear Panel Fuse and Voltage Select Locations	2-1
3-1 Front Panel (Model 548B)	3-1
3-2 Status Display	3-2
3-3 Signal Input Connectors (Model 548B)	3-3
3-4 Rear Panel	3-3
3-5 Keyboard	3-5
3-6 Frequency Limits	3-17
3-7 Equipment Setup for Band 4 Operation (Option 06)	3-18
4-1 Allowable Address Codes	4-14
5-1 Source Locking Setup	5-3
5-2 Band 1 Range and Sensitivity Test Setup (10 Hz to 10 MHz)	5-3
5-3 Band 1 Range and Sensitivity Test Setup (20 MHz to 100 MHz)	5-4
5-4 Band 2 Range and Sensitivity Test Setup	5-5
5-5 Band 3 Range and Sensitivity Test Setup	5-6
5-6 Band 3 Amplitude Discrimination Test Setup	5-7
5-7 Band 4 Range and Sensitivity Test Setup (Model 578B, Option 06)	5-8
 Table	
5-1 Equipment Requirements	5-1



This Page Intentionally Left Blank.

1

GENERAL INFORMATION

DESCRIPTION

The Model 545B and Model 548B Counters are multi-function microprocessor based devices. These counters are designed to perform frequency and (optionally) power measurement. The basic frequency range of the 545B is 10 Hz to 20 GHz, while the 548B extends to 26.5 GHz. When the 548B is equipped with Frequency Extension Capability (Option 06) and used with the Model 590 and a Remote Sensor, the counter is capable of operating up to 110 GHz.

Frequency counting is divided into four bands. Band 1 is a high impedance input (1 M Ω /20 pF) and covers 10 Hz to 100 MHz. Band 2 is a 50 Ω input operating from 10 MHz to 1 GHz. Band 3 is also a 50 Ω input and covers the range of 1 GHz to 20 GHz using the 545B, and 1 GHz to 26.5 GHz using the 548B. Band 4 is an optional band and covers 26.5 to 110 GHz and is subdivided into 4 frequency ranges.

Band 4-1	26.5 - 40 GHz
Band 4-2	40 - 60 GHz
Band 4-3	60 - 90 GHz
Band 4-4	90 - 110 GHz

An optional power measurement capability (Option 02) is available to supplement Band 3. With this option, the counter can simultaneously display frequency to 100 kHz resolution and power to 0.1 dB resolution from minimum sensitivity up to +10 dBm.

OPERATING CONDITIONS

This instrument is designed to be operated at temperatures not exceeding 0 to 50 °C at relative humidity not to exceed 95% (75% over 25 °C; 45% over 40 °C). This instrument will perform to specifications at altitudes not exceeding 10,000 ft. (3050 m) and will tolerate vibration not exceeding 2 g. It is fungus resistant. The chassis is not designed to provide protection from mechanical shock or falling water particles and is intended for normal bench use in an environmentally uncontaminated area.



VENTILATION

Air circulates through the vents in the rear panel of the counter. These vents must not be obstructed or the temperature inside the counter may increase enough to reduce counter stability and shorten component life.

STORAGE

Store the instrument in an environment that is protected from moisture, dust, and other contaminants. Do not expose the instrument to temperatures below -55 °C or above 75 °C, nor to altitudes above 40,000 ft. (12,000 m).

OPTIONS AND ACCESSORIES

OPTIONS DESCRIPTION

01	DAC Output
02	Power Measurement
05	SC-cut Ovenized High Stability Timebase (Aging Rate: 5 x 10 ⁻¹⁰ /day)
06	Band 4 Frequency Extension Module. Available on Model 548B only. Required for frequencies between 26.5 GHz and 110 GHz. Frequency Extension Cable Kit (590) and remote sensor are also required.
09	Rear Input Configuration
10	Chassis Slides

ACCESSORIES DESCRIPTION

590	Frequency Extension Cable Kit
091	Remote Sensor 26.5 - 40 GHz
092	Remote Sensor 40 - 60 GHz
093	Remote Sensor 60 - 90 GHz
094	Remote Sensor 90 - 110 GHz
095	Remote Sensor 50 - 75 GHz
096	Remote Sensor 33 - 50 GHz
097	Remote Sensor 26.5 - 50 GHz

The accessories listed above are used in conjunction with Model 548B and require Option 06.

010	Transit Case
020	Rack Mount Kit
031	Operation Manual (one supplied with each instrument)
032	Service Manual (includes operation manual)
040	Service Kit
050	Sof-Pac Carrying Case

SPECIFICATIONS

GENERAL

Resolution	Front panel keyboard input select 0.1 Hz to 1 GHz (0.1 Hz resolution in Band 1 only; no frequency offset or multiplier in 0.1 Hz resolution).
Gate Time	1 ms for 1 kHz resolution; 1 s for 1 Hz resolution
Display	12 digit LED
Accuracy	± 1 count \pm timebase error
Sample Rate	Controls time between measurements variable from 100 ms typ. to 10 s. Switchable Hold position freezes display indefinitely.
Reset	Resets display to zero and initiates new reading
Offsets	Keyboard control of frequency offsets (standard) and power offsets (standard with power measurement Option 02). Displayed frequency (power) is offset by entering value to 1 Hz resolution (0.1 dB power).
Operation Temp.	0 to 50 °C
Power	100/120/220/240 VAC $\pm 10\%$ (selectable) 50 to 60 Hz
Weight, Net	26 lb (11.8 kg)
Weight, Shipping	32 lb (14.5 kg)
Dimensions (hwd)	3.5" x 16.75" x 14" (89 mm x 425 mm x 356 mm)
Accessories Furnished	Power Cord and Operation Manual

BAND 1

Frequency Range	10 Hz to 100 MHz
Sensitivity	25 mV rms
Impedance	1 M Ω /20 pF
Connector	BNC (female)
Max. Input Level	1 V rms
Damage Level	150 V rms (above 1 kHz, damage level will decrease at 6 dB/octave down to 3.0 V rms)



BAND 2

Frequency Range	10 MHz to 1 GHz
Sensitivity	-20 dBm
Dynamic Range	30 dB
Impedance	50 Ω nominal
Connector	BNC (female)
Max. Input Level	+10 dBm
Damage Level	+27 dBm
Acquisition Time	<50 ms

BAND 3

Frequency Range	1 GHz to 20 GHz (26.5 GHz for Model 548B)
Sensitivity	-30 dBm (1 GHz to 12.4 GHz) -25 dBm (12.4 GHz to 20 GHz) -20 dBm (20 GHz to 26.5 GHz)
Dynamic Range	40 dB (1 GHz to 12.4 GHz) 35 dB (12.4 GHz to 20 GHz) 30 dB (20 GHz to 26.5 GHz)
Impedance	50 Ω nominal
Connector	Precision Type N (female) (Model 545B) APC 3.5 (female) (Model 548B)
Max. Input Level	+10 dBm
Damage Level	30 watts (+45 dBm)
Acquisition Time	<200 ms independent of frequency
Amplitude Discrimination	10 dB, if <10 dB, will count one signal accurately if separated by >200 MHz
FM Tolerance	20 MHz p-p up to 10 MHz rate
VSWR	<2.5:1 typical
Frequency Limits	Keyboard control of desired limits (standard). Counter will measure largest signal within programmed limits. Signal outside operating band must be separated by at least 100 MHz from either limit. For signal more than 10 dB above desired signal, required separation is typically 200 MHz.

1/GENERAL INFORMATION

TCXO TIMEBASE

Frequency	10 MHz
Aging Rate	$< 1 \times 10^{-7} $ per month, $< 1 \times 10^{-6} $ per year
Short Term Stability	$< 1 \times 10^{-9} $ rms for one second averaging time
Temperature Stability	$< 1 \times 10^{-6} $ 0 to 50 °C when set at 25 °C
Line Variation Stability	$< 1 \times 10^{-7} $ $\pm 10\%$ change
Warm-up Time	30 minutes
Output Frequency	10 MHz, square-wave, 1 V p-p minimum into 50 Ω
Ext. Time Base	Requires 10 MHz 1 V p-p minimum into 300 Ω
Phase Noise	-95 dBc/Hz at 10 Hz from carrier

OPTION 01 - DIGITAL TO ANALOG CONVERTER

Output Voltage	0.000 V to 0.999 V (relative to input frequency)
Accuracy (25 °C)	$\pm 0.5\% \pm 1$ mV
Temp. Stability (0 to 50 °C)	$\pm 0.01\%/^{\circ}\text{C}$
Resolution	1 mV
Load Impedance	1 kW minimum
Connector	BNC female (on rear panel)
Protection	± 10 V ac or dc applied to output connector will not cause damage. No damage will occur by any load.

OPTION 02 - POWER METER

Range	Entire Operating Range of Band 3
Accuracy	± 1.2 dB Typical 0 to 50 °C ± 0.5 dB Typical 25 °C
Resolution	0.1 dB from sensitivity to -10 dBm 0.2 dBm to maximum input
Power Offset	Math function. Allows displayed reading to be offset to 0.1 dB resolution. Selectable from front panel or via GPIB.
Conversion Time	1 gate time +50 ms



OPTION 05 - OVENIZED HIGH STABILITY TIMEBASE

Frequency	10 MHz
Aging Rate	$<5 \times 10^{-10}/24$ hours (after one hour warm-up), $1 \times 10^{-7}/\text{year}$
Short Term Stability (1 s average)	$<1 \times 10^{-10}$ rms
0 to +50 °C Temperature Stability	$<3 \times 10^{-8}$
±10% Line Voltage Change	$<2 \times 10^{-10}$
Warm-up Time	Within $\leq 5 \times 10^{-9}$ of final value 10 minutes after turn-on at 25 °C Within 1×10^{-9} of final value 30 minutes after turn-on at 25 °C
Phase Noise	-120 dBc/Hz at 10 Hz from carrier

OPTION 06 - FREQUENCY EXTENSION (548B ONLY)

Frequency Range	26.5 GHz to 110 GHz in bands with external sensors
Sensitivity	-25 dBm
Dynamic Range	30 dB
Connector	As required by remote sensor
Max. Input Level	+5 dBm
Damage Level	+10 dBm
Amplitude Discrimination	20 dBm
Acquisition Time	<1 s

REMOTE SENSOR	BAND	FREQUENCY RANGE (GHz)	WAVEGUIDE SIZE	WAVEGUIDE FLANGE	POWER RANGE (dBm)	DAMAGE LEVEL (dBm)
91	4-1	26.5 - 40	WR-28	UG-599/U	-25/-20 to +5	+10
92	4-2	40 - 60	WR-19	UG-383/U	-25 to +5	+10
93	4-3	60 - 90	WR-12	UG-387/U	-25 to +5	+10
94	4-4	90 - 110	WR-10	UG-387/U	-25 to +5	+10
95	4-2 or 4-3	50 - 75	WR-15	UG-385/U	-25 to +5	+10
96	4-1 or 4-2	33 - 50	WR-22	UG-383/U	-25 to +5	+10
97	4-1 or 4-2	26.5 - 50	K-Connector	UG-387/U	-20 to +5	+10

OPTION 09- REAR PANEL INPUT CONNECTORS

Band 1 Connector	BNC (female)
Band 2 Connector	BNC (female)
Band 3 Connector	Precision Type N (female) (Model 545B) APC 3.5 (female) (Model 548B)

OPTION 10- CHASSIS SLIDES

Dimensions See figure on following page.

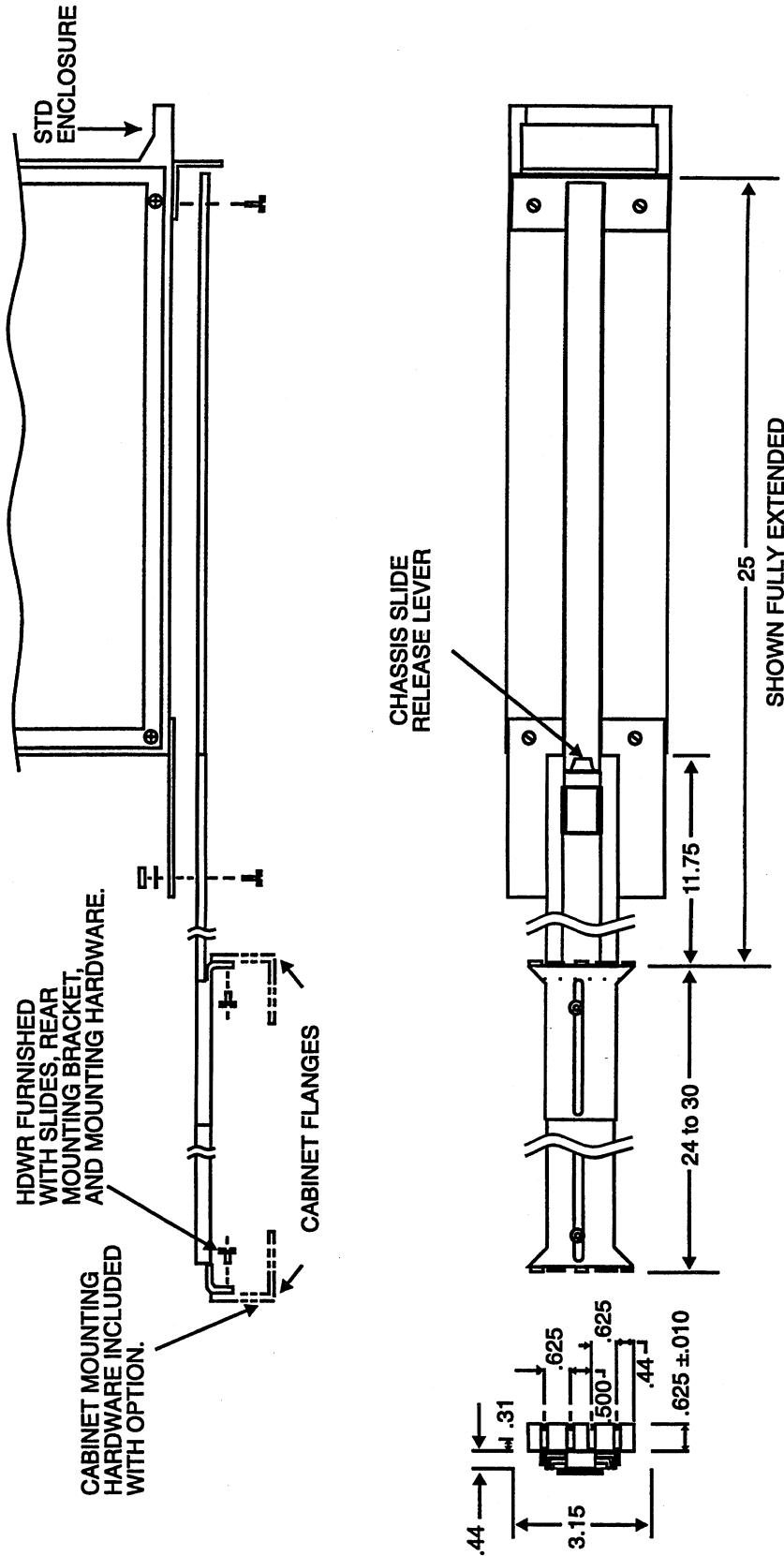

NOTE: DIMENSIONS SHOWN IN INCHES.

Figure 1-1. Option 10, Chassis Slides

DECLARATION OF CONFORMITY

Application Of Council Directive 89/336/EEC

Standards to which Conformity is Declared:

EMC: EN50011
EN50082-1

Standards to which Compliance is Declared:

Safety: IEC 1010-1 (1990)

Manufacturer's Name: EIP/Phase Matrix, Inc.
Manufacturer's Address: 109 Bonaventura Dr.
San Jose, CA 95134
Type of Equipment: Frequency Counter
Model Name(s): 545B/548B
Tested By: Rockford Engineering Services, Inc.
9959 Calaveras Road
Sunol, CA 94586 USA
Project Engineer: Mr. Bruce Gordon and Leo Hernandez
Reviewer: Mr. Michael Gbadebo, P.E.

I, the undersigned, hereby declare that the equipment specified above conforms to Directives and Standards listed.

For: **Phase Matrix, Inc.**

Name: Mark Espinosa
Title: QA Manager

Signature: Mark Espinosa

Date: 11/01/2004

2

INSTALLATION

UNPACKING

The EIP 545B/548B series Microwave Frequency Counters arrive ready for operation. Carefully inspect the shipping carton for any sign of visible or concealed damage. If the carton is damaged, immediately notify shipper's agent.

Remove the packing carton and supports, being careful not to scar or damage the instrument. Make a complete visual inspection of the counter, checking for any damage or missing components. Check that all switches and controls operate mechanically. Report any damage to EIP immediately.

INSTALLATION

There are no special installation instructions for these units. The units are self-contained bench or rack mounted instruments, which only require connection to a standard, single-phase power line for operation.

CAUTION

Always be sure that the fuse is the type and value specified, and that the voltage select switch is set to correspond to the ac power input voltage; otherwise, the counter may be damaged.

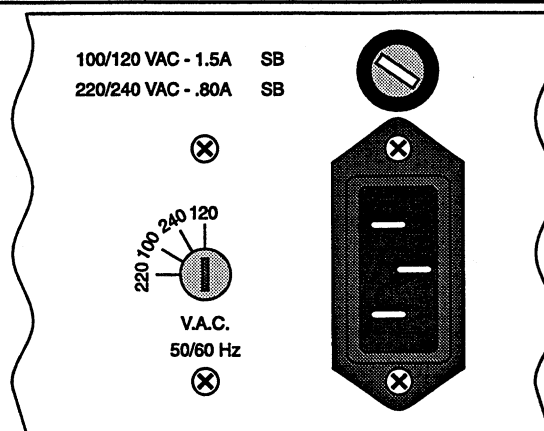

Figure 2-1. Rear Panel Fuse and Voltage Select Locations.



VOLTAGE SELECTION

The voltage select switch (V.A.C.) must be set to the proper line voltage. To change the line voltage, disconnect the counter from the power line and, using a screwdriver, set the V.A.C. switch to the desired position.

FUSE REPLACEMENT

The fuse for the counter is located on the rear panel above the line voltage socket (Figure 2-1). The following fuse types must be used:

Line Voltage	Fuse Type
100/120 Vac	1.5 A Slow-blow MDL
200/220 Vac	0.8 A Slow-blow FST

To release the fuse, use a screwdriver to rotate the slotted cap counter-clockwise. To reinstall the fuse, press the fuse and slotted cap assembly into the fuse cavity and turn it clockwise until it locks into place.

INCOMING OPERATIONAL CHECK

The following procedure can be performed without special tools or equipment.

1. Before connecting power to the instrument, check to make sure the correct fuse is installed and the V.A.C. switch is set properly.
2. Connect the power cord to the appropriate single-phase power source. The ground terminal on the power cord plug must be properly grounded.
3. Turn the POWER switch on. Dashes will be displayed for about one second. The counter should then display all zeros indicating that the automatic self-check has been successfully completed.

4. PRESS: Display should read 200 000 000 ±1.

5. PRESS: Display should read all 8's and all annunciators should be lit.

6. PRESS: Each display segment should light in turn.

7. PRESS: Each digit should light in turn.

This completes the incoming operational check.

SERVICE INFORMATION

PERIODIC MAINTENANCE

No periodic preventive maintenance is required. To maintain accuracy, it is recommended that the counter be recalibrated every 12 months. For further information, refer to the service manual.

CAUTION

Do not attempt repair or disassembly of the Microwave Converter, Millimeter Wave Converter, or Timebase Oscillator assemblies. Such action will void the warranty of the counter. Contact EIP or your sales representative.

COUNTER IDENTIFICATION

This counter is identified by three sets of numbers: the Model Number: 545B or 548B, Serial Number, and a configuration control number (CCN). They are located on a label affixed to the frame at the rear of the counter. These numbers must be included in any correspondence regarding your counter.

FACTORY SERVICE

If the counter is being returned to EIP for service or repair, be sure to include the following information with the shipment.

- Name and address of owner.
- Model, complete serial number, and CCN of the counter.
- A complete description of the problem (i.e. Under what conditions did the problem occur? What was the signal level? What equipment was attached or connected to the counter? Did that equipment experience failure symptoms?).
- Name and telephone number of someone familiar with the problem that may be contacted by EIP for any further information if necessary.
- Shipping address to which the counter is to be returned. Include any special shipping instructions.

Pack the counter for shipping as detailed below.

SHIPPING INSTRUCTIONS

Wrap the counter in heavy plastic or kraft paper, and repack in original container if available. If the original container cannot be used, use a heavy (275 pound test) double-walled carton with approximately four inches of packing material between the counter and the inner carton. Seal carton with strong filament tape or strapping. Mark the carton to indicate that it contains a fragile electronic instrument. Ship to the EIP address on the title page of this manual.



This Page Intentionally Left Blank.

3

OPERATION

INTRODUCTION

This section lists the counter controls, connectors, and indicators, explains how each counter function operates, and provides some general measurement considerations.

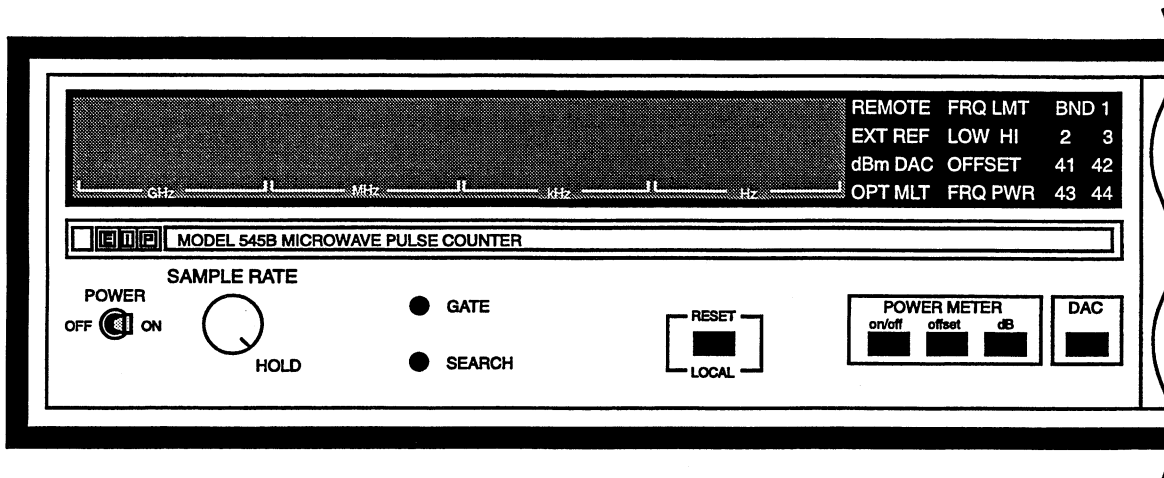

Figure 3-1. Front Panel (Model 545B).

FRONT PANEL CONTROLS, CONNECTORS, AND INDICATORS

- POWER switch - turns counter on.
- SAMPLE RATE/HOLD control - varies time between measurements from 0.1 to 10 seconds (nominal). (Gate time is added to sample time, thus the minimum reading for 1 Hz resolution is 1.1 seconds.) The last reading is retained indefinitely in HOLD until Reset is issued.
- GATE indicator - lights when the signal gate is open and a measurement is being made.
- SEARCH indicator - lights when the counter is not locked to an input signal.
- Data display - The 12 digit LED display provides a direct numerical readout of a measurement or of an input frequency. The frequency readout is displayed in a fixed position format that is sectionalized in GHz, MHz, kHz and Hz. Power information is displayed in dBm to 0.1 dB resolution, on the three right-most digits. When both power and frequency are displayed, frequency resolution is limited to 100 kHz.



- Status display - a series of annunciators provided to indicate current operating status of the counter.
- Keyboard - both data entry and function selection are controlled through the keyboard (see Keyboard Section on page 3-5).

REMOTE	FRQ	LMT	BND	1
EXT	REF	LOW	HI	2 3
dBm	DAC	OFFSET		41 42
OPT	MLT	FRQ	PWR	43 44

Figure 3-2. Status Display.

STATUS DISPLAY

- REMOTE - lights to indicate that front panel controls are disabled and that the counter is being controlled through the GPIB interface.
- EXT REF - lights to indicate the counter is set to an external timebase reference

CAUTION

When EXT REF lights it does NOT indicate that correct signal level has been applied.

- dBm - lights to indicate that the Power Meter (Option 02) is active.
- DAC - lights to indicate that the Digital-to-Analog Converter (Option 01) is active.
- OPT - lights to indicate that a special option is active.
- MLT - lights to indicate the multiplier function is active.
- FRQ LMT LOW - lights when Band 3 frequency limit low is active.
- FRQ LMT HI - lights when Band 3 frequency limit high is active.
- OFFSET FRQ - lights when frequency offset is active.
- OFFSET PWR - lights when power offset is active.
- BND 1, 2, 3, 41, 42, 43, or 44 - lights to indicate which operating range has been selected. When any Band 4 annunciator is lit it indicates that the Extended Frequency Capability, Option 06, has been selected (548B only).

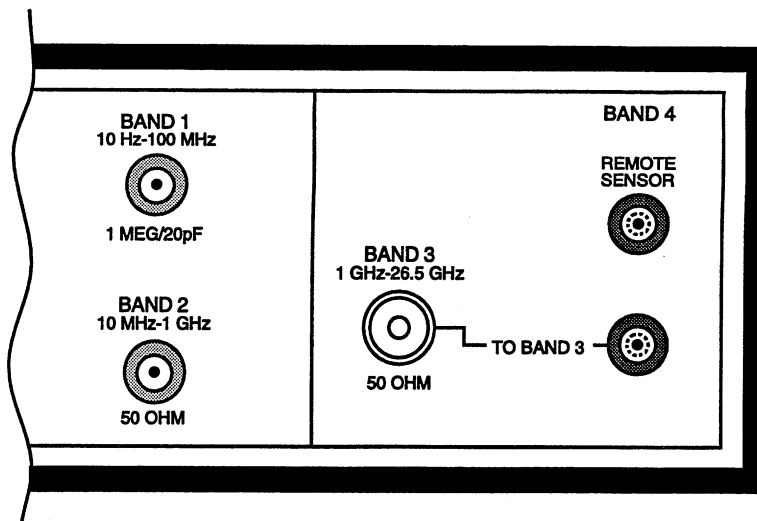

Figure 3-3. Signal Input Connectors (Model 548B).

SIGNAL INPUT

- BAND 1 input connector (BNC female) - has a nominal input impedance of 1 M Ω , shunted by 20 pF. It is used for measurements in the range of 10 Hz to 100 MHz.
- BAND 2 input connector (BNC female) - has a nominal input impedance of 50 Ω . It is used for measurements in the range of 10 MHz to 1 GHz.
- BAND 3 input connector (precision type N female for the Model 545B, APC-3.5 female for Model 548B) - has a nominal input impedance of 50 Ω . It is used for measurements in the range of 1 GHz to 20 GHz (26.5 for Model 548B).
- BAND 4 (Option 06, Model 548B only) - is a Selectro quick connect connector with a nominal input impedance of 50 Ω . It is used for measurements in the range of 26.5 GHz to 110 GHz. This input is used in conjunction with the Model 590 Frequency Extension Cable Kit and a remote sensor.

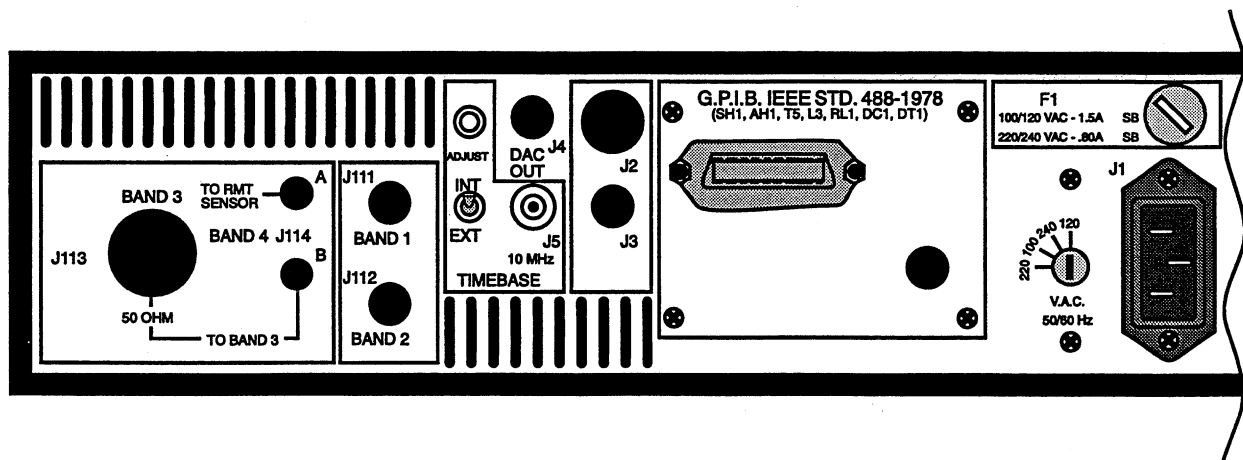

Figure 3-4. Rear Panel.



REAR PANEL CONTROLS AND CONNECTORS

- Spaces labeled BAND 1, BAND 2, BAND 3, BAND 4, and TO RMT SENSOR - are used on instruments equipped with Option 09, Rear Panel Input.
- TIMEBASE ADJUST control - is used with option 05 only. Screwdriver adjustment allows precise setting of the internal oven oscillator.
- TIMEBASE INT/EXT switch - selects either the internal timebase or an external 10 MHz reference.
- TIMEBASE connector (BNC female) - allows monitoring of internal 10 MHz timebase or input of an external 10 MHz reference.
- DAC OUT connector (BNC female) - provides a analog voltage proportional to any specified three digits of frequency displayed, in instruments equipped with Option 01, Digital to Analog Converter.
- G.P.I.B. connector - is used for remote operation with the IEEE 488 - 1978 General Purpose Interface Bus.
- F1 fuse - provides current overload protection.
- V.A.C. switch - sets the operating voltage of the counter to match power line voltage.

CAUTION

Switch setting and fuse rating must match power line voltage. Refer to Installation Section for more information.

- AC power connector - accepts the power cord supplied with the counter.

INSTRUMENT DEFAULT SETTINGS

When the counter is initially turned on the state of the counter is determined by a set of default values which are stored in memory. The factory-set values are listed below.

Parameter	Default Value
Band	3 (Microwave Band)
Subband	1
Resolution	0 (1 Hz)
Frequency Multiplier	01
Frequency Offset	0 Hz
Frequency Limit Low	950 MHz
Frequency Limit High	20.5 GHz (Model 545B) 26.7 GHz (Model 548B)
Frequency Display	On

KEYBOARD

The keyboard consists of 16 push button keys that control the major functions of the counter. Twelve keys are used for numerical data entry—the digits 0 through 9, the decimal point and the change sign (\pm). Two keys (MHz and GHz) act as terminators for the input of frequency offset, frequency limits, or phase lock frequency. The CLEAR DATA and CLEAR DISPLAY keys are used to clear stored or displayed data. Twelve of the keys are also used to select the band, resolution, test function, frequency offset, frequency multiplier, frequency limits, band width, lock frequency, phase lock, store, and recall function.

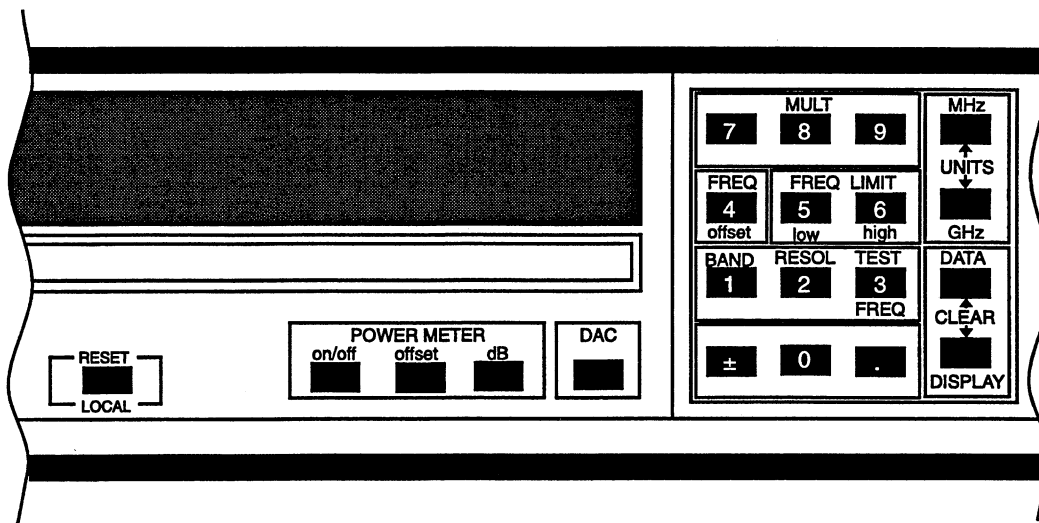

Figure 3-5. Keyboard.

RESET/LOCAL

RESET/LOCAL is a dual function key. When the counter is in remote, pressing the RESET/LOCAL key once causes the counter to return to local. When in local, pressing the RESET/LOCAL key resets the counter and converter and initiates a new measurement.

UNITS (MHz/GHz)

The MHz and GHz keys are terminators for the input of frequency offset, frequency limits, and phase lock frequency.

CLEAR DATA/CLEAR DISPLAY

Keyboard Examples:

PRESS:  to return data of selected function to default state. Clears limits, offsets, DAC, multiplier, bandwidth, lock frequency, and stored phase lock information.

PRESS:  to clear display. Does not affect stored data. Restores counter to display measurement. Clears entry if counter is in data entry mode.



COUNTER CONTROL FUNCTIONS

BAND SELECTION

The BAND key followed by a numeric key selects the desired band.

Keyboard Examples:

PRESS: to select Band 1.

PRESS: to select Band 2.

PRESS: to select Band 3.

GPIB Examples:

Enter: OUTPUT 719;"B1" to select Band 1.

Enter: OUTPUT 719;"B2" to select Band 2.

Enter: OUTPUT 719;"B3" to select Band 3.

On the Model 548B equipped with Option 06, four additional frequency bands may be selected (Band 41 thru 44).

Keyboard Examples:

PRESS: where X is a number between 1 and 4.

PRESS: to select Band 42.

GPIB Examples:

Enter: OUTPUT 719;"41" to select Band 41.

Enter: OUTPUT 719;"44" to select Band 44.

RESOLUTION/GATE TIME SELECTION

The RES key followed by a numeric key between 0 and 9 set the least significant digit of the display as a power of 10, thereby selecting measurement resolutions from 1 Hz to 1 GHz. Since the gate time is determined by the selected resolution, this key also (indirectly) selects the gate time.

Keyboard Examples:

PRESS: to select a 1 Hz resolution (1 second gate time).

PRESS: to select a 10 Hz resolution (.1 second gate time).

PRESS: to select a 100 Hz resolution (.01 second gate time).

PRESS: to select a 1 kHz resolution (1 ms gate time).

PRESS: to select a 10 kHz resolution (1 ms gate time).

PRESS: to select a 1 GHz resolution (1 ms gate time).

GPIB Examples:

Enter: OUTPUT 719;"R0" to select a 1 Hz resolution.

Enter: OUTPUT 719;"R1" to select a 10 Hz resolution.

Enter: OUTPUT 719;"R6" to select a 10 MHz resolution.

Enter: OUTPUT 719;"R9" to select a 1 GHz resolution.

0.1 Hz RESOLUTION

In Band 1 only, the counter also provides a 0.1 Hz resolution. When 0.1 Hz is selected in Band 1, the significance of the digits on the front panel display is shifted left 3 digits. For example, a 9 MHz signal input is displayed as 9 GHz. One digit is displayed to the right of the decimal, and the two right-most digits are blanked out. The display digit to the right of the decimal will be zero until the measurement is updated at the end of the 10 second gate interval.

Keyboard Example:

PRESS: to select Band 1.

PRESS: to select a 0.1 Hz resolution.



GPIB Example:

Enter: OUTPUT 719;"B1" to select Band 1.

Enter: OUTPUT 719;"R.1" to select a 0.1 Hz resolution.

FREQUENCY LIMITS

The frequency limit keys enable entry of low and/or high frequency limits to 10 MHz resolution in Band 3. The converter is reset after the entry sequence.

TO INPUT FREQUENCY LIMITS

Keyboard Example:

PRESS: to display the low frequency limit last entered. (Notice flashing annunciator.)

PRESS: (the corresponding number key) to select desired frequency low limit to 10 MHz resolution.

PRESS: or to terminate the input sequence. (Notice FRQ LMT LOW annunciators solidly lit after terminator key is released.)

PRESS: to set a low frequency limit of 2 GHz.

PRESS: to display the high frequency limit last entered. (Notice flashing annunciator.)

PRESS: (the corresponding number key) to select desired frequency high limit to 10 MHz resolution.

PRESS: or to terminate the input sequence. (Notice FRQ LMT LOW annunciators solidly lit after terminator key is released.)

PRESS: to set a high frequency limit of 6 GHz.

GPIB Example:

Enter: OUTPUT 719;"FL2GHZ" to select a low frequency limit of 2 GHz.

Enter: OUTPUT 719;"FH6GHZ" to select a high frequency limit of 6 GHz.

TO DISPLAY STORED LIMITS

Keyboard Example:

PRESS: or to display stored frequency low/high limit.

PRESS: to return counter to measurement display mode.

TO CLEAR FREQUENCY LIMITS

Keyboard Example:

PRESS: or

NOTE

High and low limits should be separated by at least 100 MHz.

GPIB Example:

Enter: OUTPUT 719;"FLP" to reset low frequency limit to factory default.

Enter: OUTPUT 719;"FHP" to reset high frequency limit to factory default.

DATA MANIPULATION FUNCTIONS

FREQUENCY OFFSET

Frequency offset function enables the entry of a positive or negative frequency offset to 1 Hz resolution. The offset will be incorporated into the frequency measurement after the next gate.

TO INPUT FREQUENCY OFFSETS

Keyboard Example:

PRESS: to display frequency offset last entered. (Notice flashing annunciator.)

PRESS: (the corresponding number key) to select desired offset frequency to 1 Hz resolution.

PRESS: or to terminate the input sequence. (Notice FRQ OFFSET annunciators solidly lit after terminator key is released.)

PRESS: to set a frequency offset of 2 GHz.

GPIB Example:

Enter: OUTPUT 719;"FO2GHZ" to select 2 GHz frequency offset.

Enter: OUTPUT 719;"FOP" to clear frequency offset.



TO DISPLAY STORED OFFSET







Keyboard Example:

PRESS:  to display stored offset.

PRESS:  to return counter to measurement display mode.

TO CLEAR FREQUENCY OFFSETS

Keyboard Example:

PRESS:   or    or  

GPIB Example:

Enter: OUTPUT 719;"FOP" to remove frequency offsets.

MULTIPLY FUNCTION



The multiply function multiplies the measured frequency by a positive integer between 1 and 99. The result is displayed to 1 kHz resolution. The multiplier will be incorporated into the frequency measurement after the next gate.

TO ENTER MULTIPLIER

Keyboard Example:

PRESS:  to display multiplier last entered. (Notice flashing annunciator.)

PRESS:   (the corresponding number keys) to select desired multiplier. (Notice MLT annunciator solidly lit after second key is released.)

PRESS:    to set a frequency multiplier of 2.

GPIB Example:

Enter: OUTPUT 719;"ML02" to set a frequency multiplier of 2.





Enter: OUTPUT 719;"ML99" to set a frequency multiplier of 99.

TO DISPLAY MULTIPLIER

Keyboard Example:

PRESS:  to display stored frequency multiplier.PRESS:  to return counter to measurement display mode.**TO CLEAR MULTIPLIER**

Keyboard Example:

PRESS:   or   

GPIB Example:

Enter: OUTPUT 719;"MLP" to clear the multiplier function.

mX±B

By using the frequency offset and multiply functions the counter can automatically perform mX±B calculations.

The equation for the function performed is:







Displayed Reading = mX±B where m = Multiplier (00 to 99) entered from keyboard.

X = Input frequency.

±B = Frequency offset entered from the keyboard.

To do mX±B calculation for m = 2, b = 70 MHz

Keyboard Example:

PRESS:    and    **DAC****DESCRIPTION**

The DAC key provides control of the optional (Option 01) digital-to-analog converter. This key is used to select three consecutive display digits. The selected digits are converted to an analog voltage between 0 and .999 volts and applied to the rear panel connector. The output voltage corresponds to the numeric display, substituting zeros for any non-numeric characters that appear. The output will be updated after every display update.



KEYBOARD OPERATION

To enable the DAC (Digital to Analog Converter), press the DAC key followed by two digits (01-12). The number keyed in will select the most significant digit.

Keyboard Examples:

PRESS: to select the 1 kHz, 100 Hz, and 10 Hz digits.

PRESS: to select the 1 MHz, 100 kHz, and 10 kHz digits.

PRESS: to turn the DAC off.

GPIB Examples:

Enter: OUTPUT 719;"DC04" to turn on the DAC and select the 1 kHz, 100 Hz, and 10 Hz digits.

Enter: OUTPUT 719;"DC07" to turn on the DAC and select the 1 MHz, 100 kHz, and 10 kHz digits.

Enter: OUTPUT 719;"DC12" to turn on the DAC and select the 100 GHz, 10 GHz, and 1 GHz digits.

Enter: OUTPUT 719;"DCP" to turn off the DAC.

POWER METER

DESCRIPTION

The POWER METER keys provide control of the optional (Option 02) power meter. The power meter option measures the power of signals applied to Band 3. The power is displayed (to 0.1 dB resolution) simultaneously with frequency (to 100 kHz max. resolution). For AM and FM averaging purposes, gate time is controllable in the power meter mode through the resolution function. Power gate time mirrors frequency gate time. For example, in resolution 0 the frequency gate time is 1 second, and the power gate time is 1 second. In resolution 1 the frequency gate time is 100 ms, and the power gate time is 100 ms. Option 02 allows power offsets from -99.9 dB to 99.9 dB, with a 0.1 dB resolution and will not degrade the basic performance of the counter.

KEYBOARD OPERATION

Three keys control the power measurement function.

Keyboard Examples:

PRESS: to activate/deactivate power meter.

PRESS: to activate the power offset function.

PRESS: to terminate power offset function.

GPIB Examples:

Enter: OUTPUT 719;"PA" to turn on the power meter.

Enter: OUTPUT 719;"PP" to turn off the power meter.

Enter: OUTPUT 719;"PO10DB" to set a power offset of 10 dB.

Enter: OUTPUT 719;"PO1DB" to clear a power offset.

Enter: OUTPUT 719;"OP" to disable offsets.

Enter: OUTPUT 719;"OA" to enable offsets.

TEST SELECTIONS

This counter incorporates an automatic power-on self-test along with a variety of performance, calibration and troubleshooting tests accessible from the front panel.

POWER-ON TESTS

The power-on tests are automatically performed by the counter and verify proper operation of most functional areas of the counter. As part of the power-on tests, the counter checks its RAM and PROM memory. During these tests, dashes are displayed on the front panel. If all tests pass, the counter will begin normal operation about one second after turn-on. If the RAM test fails, all 12 sections of the display will read "E", which indicates that either the RAM or RAM decoding circuitry is faulty. If the PROM test fails, the error message will be displayed indicating that either the PROM or the PROM decoding circuitry is faulty.

TEST FUNCTIONS

In addition to the power-on tests, the counter features a variety of other performance, calibration, and configuration tests accessible via the TEST key on the front panel. The following is a list of these tests:

TEST 01 — 200 MHz Self-Test

This function is used to verify that the Count Chain, Gate Generator, and the VCO are operational.

PRESS: to activate this test.

When this function is entered, the counter will do the following:

1. Exit the current band.



2. Set the hardware to the self-test mode.
3. Set the VCO to 400 MHz.
4. Set the counter to take frequency measurements only.
5. Begin frequency measurements.

The display will show the frequency measurement results. These results will be output to the GPIB interface when frequency readings are requested. The measurement result should be 200 MHz \pm 1 count.

TEST 02 — Light Display Segments Test

This test will light all LEDs, annunciators, and decimal points. It is used to verify that all displays light, to check the intensity of the display, and to align the LEDs and annunciators.

PRESS: to activate this test.

TEST 03 — Scan Display Segments Test

This test lights each segment of every digit and each annunciator in every bank sequentially. The cycle rate can be adjusted with the sample rate control. It is used to verify that each segment of the display, each segment driver, and the display multiplexer operates properly and independently.

PRESS: to activate this test.

TEST 04 — Scan Display Digits Test

This test lights all segments of each digit and its decimal point simultaneously. The test cycles through all digits and annunciators. The cycle rate is determined by the sample rate control. It is used to check each digit and digit driver independently, and verifies operation of the display multiplexer.

PRESS: to activate this test.

TEST 05 — Keyboard Test

This function is used to verify the operation of the keyboard.

After this function is activated, the counter stops normal operation. The display shows the key code of the last key pressed. When a new key is pressed, the display is updated to show the code of the new key. When the GPIB controller requests a key code, the code of the last key pressed is output. (If the controller requests a key code, the counter will output to the GPIB interface the code of the last key pressed even if Special Function 05 is not activated). If the counter is in LOCAL, this function must be terminated by the CLEAR DISPLAY key. If it is in remote, this function can be terminated by any device-dependent command.

PRESS: to activate this test.

TEST 06 — Converter Ramp Test

This test continuously ramps the Band 3 Converter DAC through its range. It is used to test the YIG DAC, YIG drivers, YIG, and Band 3 RF level circuits.

PRESS: to activate this test.

TEST 07 — Sweep VCO Test

This test cycles the VCO from 400 to 500 MHz in increments of 50 kHz. The cycle rate can be adjusted using the sample rate control. It is used to test the VCO and phase lock circuitry.

PRESS: to activate this test.

TEST 08 — Power Meter Offset Test

This test sets the power meter zero DAC. The setting is entered as a four digit hexadecimal number. The first two digits are used to program the coarse offset DAC, and the last two digits program the fine offset DAC. Test 08 enables the power meter zero DAC to be tested, and provides a DC level signal to aid in troubleshooting power meter circuitry.

PRESS: to activate this test.

TEST 09 — Power Meter Gain Test

This test sets the power meter sensing circuit to a selected number. The number is entered as a five-digit hexadecimal number in the following format:

1st digit	A107U10 bits 4-7
2nd digit	A107U10 bits 0-3
3rd digit	A107U12 bits 4-7 (Power Meter Option only)
4th digit	A107U12 bits 0-3 (Power Meter Option only)
5th digit bit 0	Sets Amp marked "15 dB Gain" to high gain.
5th digit bit 1	Sets Amp marked "30 dB Gain" to high gain.

Digit 5 is a 2-bit number, so any number entered for digit 5 will be justified to a number from 0-3. Test 09 tests the RF level and power meter circuits.

PRESS: to activate this test.



TEST 10 — Memory Read/Alter Routine

Test 10 reads the microprocessor address and, if that address is RAM or I/O, can change its contents. The desired address is entered as a 4-digit hexadecimal number. When the 4th digit is entered, the counter displays the contents of the entered address. The contents can then be changed by entering a two-digit hexadecimal number.

NOTE

Access to this test is controlled by an internal memory protect switch. Attempting to access this test without switching the memory protect switch will cause the counter to generate an error message.

TEST 90 — Display and/or Alter GPIB Address

When this function is activated, the counter displays the current address of the GPIB interface. If the address does not need to be changed, the function can then be terminated by pressing the CLEAR DISPLAY key.

After this function has been activated, the GPIB address can then be changed by entering a two-digit number between 01 and 99, inclusive.

PRESS: to activate this test.

PRESS: to set the GPIB address to 19.

PRESS: to exit the test.
DISPLAY

TEST 91 — YIG DAC Automatic Calibration

This function is used to calibrate the Band 3 input filter. Refer to the service manual for complete information.

NOTE

Access to this test is controlled by an internal memory protect switch. Attempting to access this test without switching the memory protect switch will cause the counter to generate an error message.

TO EXIT TESTS

PRESS: to exit a test and return to normal operation.
DISPLAY

MUTUALLY EXCLUSIVE FUNCTIONS

1. When self-test (Test 01) is active, all other counter functions are inactive with the exception of the resolution function. If any key is pushed when the counter is in self-test, the test is exited.
2. The power meter function is terminated whenever BAND 1, 2, or 4 is selected.

SIGNAL MEASUREMENTS WITH THE 545B/548B

AUTOMATIC FREQUENCY MEASUREMENTS

To measure the frequency of a CW signal, apply the signal to input connector that corresponds to the frequency being measured and select the appropriate band. The counter will then proceed to automatically find the signal, measure it and display the measured frequency.

MULTIPLE SIGNAL MEASUREMENTS

In actual microwave environments there are often multiple signals present. In a multi-signal environment the counter will automatically find and measure the largest signal, as specified by amplitude discrimination.

In Band 3, the counter can also measure signals other than the largest signal present. This is accomplished by setting frequency limits around the desired signal. Figure 3-6 shows an example of the frequency limits feature.

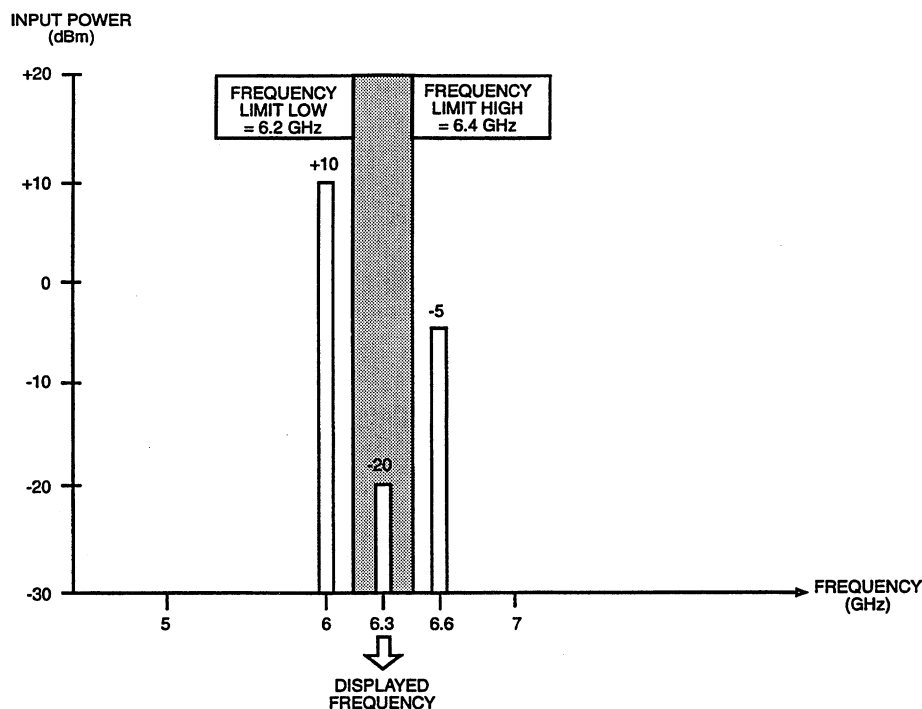

Figure 3-6. Frequency Limits.



If the signals shown in Figure 3-6 are applied to Band 3 of the counter, it will automatically find the signal at 6 GHz since it is the largest signal. If it is desired to measure the signal at 6.3 GHz, set the low frequency limit at 6.2 GHz and the high frequency limit to 6.4 GHz. This will prevent the counter from seeing either the signal at 6 GHz or the signal at 6.6 GHz.

OPTIONS

MILLIMETER WAVE MEASUREMENTS

The 548B offers an extended frequency option (Option 06) that allows operation between 26.5 GHz and 110 GHz. This band is designated as Band 4 on the counter and is divided into four subbands as shown below.

Band	Frequency Range
41	26.5 - 40 GHz
42	40 - 60 GHz
43	60 - 90 GHz
44	90 - 110 GHz

To perform measurements in this range, the Model 590 Frequency Extension Cable Kit and one or more of the remote sensors are required.

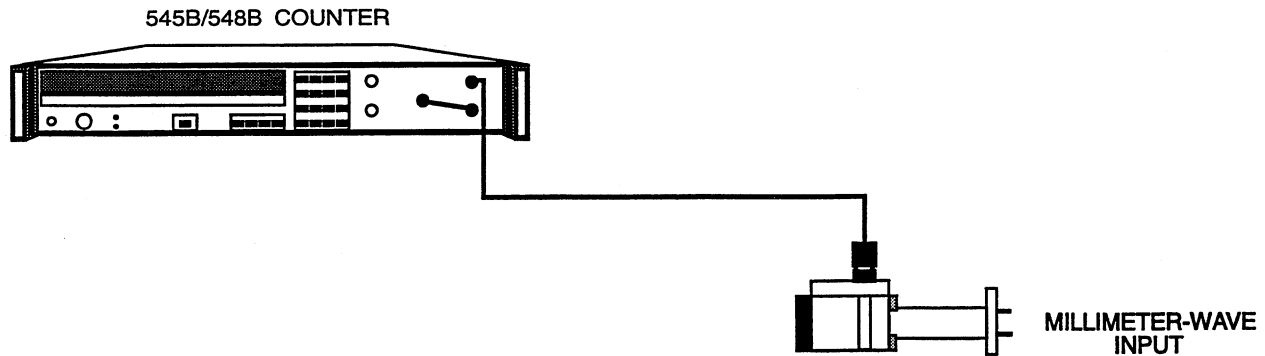

Figure 3-7. Equipment Setup for Band 4 Operation (Option 06).

CAUTION

Before connecting the remote sensor to the frequency source, verify that the power level is within the limits specified for the sensor. Static discharge or ground loops can damage or destroy the diode in a remote sensor. **ALWAYS** connect the LO cable to the counter first, then touch the shield to the body of the sensor before connecting. Be sure that the counter and waveguide port to which the sensor connects have a common ground. If in doubt, connect with a ground strap before connecting the remote sensor.

Operation

To operate the counter in one of the Band 4 frequency ranges, connect the short cable (supplied with the Frequency Extension Cable Kit) from the lower Band 4 output jack on the front panel

to the Band 3 input. Connect the long cable from the upper Band 4 jack to the remote sensor. Select the desired band. Connect the remote sensor to the frequency source. The counter will automatically measure and display the frequency of the source.

ERROR MESSAGES

When an error occurs, the error number is displayed. The probable cause of each error is listed below.

OPERATOR ERRORS

- 01 Illegal key sequence.
- 02 A resolution number was not entered.
- 03 A band number was not entered; or the number entered was too large.
- 04 No power reading in current band.
- 05 Frequency limit high >20.5 GHz, 27 GHz (548B).
- 06 (Freq Limit Hi) - (Freq Limit Lo) <100 MHz.
- 07 Frequency Limit Low <.95 GHz (545B/548B).
- 09 Illegal test mode key sequence.
- 10 Illegal DAC key sequence.
- 11 Illegal multiplier key sequence.
- 12 Service request condition input error (GPIB only).
- 13 Option not installed.
- 16 Storage register 0 does not exist.
- 19 Function not allowed in 0.1 resolution.
- 20 Access to this function protected by memory protect switch.
- 40 DAC table error, cannot find YIG frequency.
- 41 Calibration frequency error.
- 42 Signal not found.

COUNTER ERRORS

- 3X EEPROM error.



This Page Intentionally Left Blank.

4

PROGRAMMING

The GPIB interface in the 545B/548B counters is fully compatible with the IEEE 488-1978 standard. With the GPIB interface, the counter can respond to remote control instructions and can output measurement results. At the simplest level, the counter can output data to other devices such as a printer. In more sophisticated systems, an instrument controller can remotely program the counter, trigger measurements, and read results.

GPIB FUNCTIONS IMPLEMENTED

The implemented GPIB interface function subsets are as follows:

Interface Function	Subset	Description
Source Handshake	SH1	complete capability
Acceptor Handshake	AH1	complete capability
Talker	T5	basic talker, serial poll, Talk Only mode, unaddress if MLA
Listener	L3	basic listener, Listen Only mode, unaddress if MTA
Service Request	SR1	complete capability
Remote Local	RL1	complete capability
Device Clear	DC1	complete capability
Device Trigger	DT1	complete capability

REMOTE/LOCAL FUNCTION

When the counter changes from LOCAL to REMOTE or vice-versa, all the stored information is retained. The counter will operate in the same state as it was before the change. The only exception is when the counter is in the TEST mode, the TEST function is automatically terminated. When the counter is in REMOTE and LOCAL LOCKOUT is not active, the RESET key on the front panel keyboard acts as the return to local key.



DEVICE CLEAR FUNCTION

When the GPIB command DEVICE CLEAR or SELECTED DEVICE CLEAR is received, the counter will revert to its power on state as listed below:

Display Active
Band 3 Selected
Resolution 0
Fast Passive
Offset Active (Offset set to 0)
Power Meter Passive
Frequency Limit High set to default
Frequency Limit Low set to default
Test Passive (Clear Test Functions)
Exponent Zero (Output Format)
Service Request Passive

DEVICE TRIGGER FUNCTION

When the GPIB bus command DEVICE TRIGGER is received, the counter will initiate a new frequency reading cycle. The converter will not be reset. If the counter does not have a converter lock, the DEVICE TRIGGER will not be performed until a converter locked condition exists.

GPIB ADDRESS SELECTION

This counter employs a software selectable GPIB address which is stored in non-volatile memory. To verify the GPIB address, select Test 90: the counter will display the current GPIB address. Press the Clear Display key to exit Test 90 without changing the GPIB address.

To change the GPIB address, select Test 90 followed by the desired GPIB address (see Figure 4-1 for list of allowable GPIB address codes).

For example:

PRESS: to select GPIB address 20.

Since the GPIB address is stored in non-volatile memory, the counter will always default to the last GPIB address selected.

The GPIB address selection is also used to put the counter in the Talk Only or Listen Only mode. To put the counter in the Listen Only mode simply set the address to 41 or higher.

TALK ONLY MODES

The TALK ONLY modes enable the counter to output data to other devices on the bus, such as a printer, without the need of an instrument controller. To use the counter in a TALK ONLY mode, enter the GPIB address corresponding to the desired mode of operation.

The counter can be put in four different modes of operation in the Talk Only mode. The following is a list of the address settings for entering these modes.

Address	Mode of Operation
32	Continuous output determined by SAMPLE RATE control. Exponent in scientific format.
33	Continuous output - fast active. SAMPLE RATE control inactive. Exponent in scientific format.
34	Continuous output determined by SAMPLE RATE control. Exponent in zero output format.
35	Continuous output - fast active. SAMPLE RATE control inactive. Exponent in zero output format.

NOTE

In the Talk Only or the Listen Only mode, the address of the counter is always automatically set to decimal 0.

GPB INSTRUCTION FORMAT

<OP CODE> <NUMBER> <TERMINATOR>

OPERATION CODE or OP CODE can take any of the following formats:

<LETTER> <LETTER> or <LETTER> <DIGIT>

Example: FH (Frequency Limit High) or B3 (Band 3)

The NUMBER portion of the statement can take the form of any of the following:

<SIGN> <DIGIT STRING>

Example: -2457

<SIGN> <DIGIT STRING> . <DIGIT STRING>

Example: -3.483

NOTE

Spaces within the <OP CODE> and <NUMBER> portions of the instructions are always ignored.

The TERMINATOR allows the operator to choose the scale of an input number as well as implement special functions.

TERMINATOR = G/M/K/H/D/P/C

G, M, K and H represent GHz, MHz, kHz and Hz respectively

D = dB

P = clear data (equivalent to CLEAR DATA key on keyboard)

C = clear display (equivalent to CLEAR DISPLAY key on keyboard)



FORMAL DEFINITION OF INSTRUCTIONS

<OP CODE> <NUMBER> <TERMINATOR>

<OP CODE> ::= <LETTER> <LETTER> | <LETTER> <DIGIT>

<NUMBER> ::= <SIGN> <DIGIT STRING> | <SIGN> <DIGIT STRING> . <DIGIT STRING> | NULL

<TERMINATOR> ::= G | M | K | H | D | P | C | NULL

<SIGN> ::= + | - | NULL

<DIGIT STRING> ::= <DIGIT> <DIGIT> <DIGIT>

<LETTER> ::= A | B | C | D | E | F | G | H | I | J | K | L | M | N | O | P | Q | R | S | T | U | V | W | X | Y | Z

<DIGIT> ::= 1 | 2 | 3 | 4 | 5 | 6 | 7 | 8 | 9 | 0

PROGRAM CODE SET

DISPLAY

DA- Display Active: Output Frequency Reading to Front Panel and Bus

DP- Display Passive: Output Frequency Reading to Bus only

DN- Display Normal

BAND

B1- Band 1: 10 Hz - 100 MHz

B2- Band 2: 10 MHz - 1 GHz

B3- Band 3: 1 GHz - 20 GHz (Model 545B / 26.5 GHz for Model 548B)

B4- Band 4: (Model 548B / Option 06)

RESOLUTION

R.1- Resolution .1 = 0.1 Hz (Band 1 only)

R0- Resolution 0 = 1 Hz

R1- Resolution 1 = 10 Hz

R2- Resolution 2 = 100 Hz

- R3- Resolution 3 = 1 kHz
- R4- Resolution 4 = 10 kHz
- R5- Resolution 5 = 100 kHz
- R6- Resolution 6 = 1 MHz
- R7- Resolution 7 = 10 MHz
- R8- Resolution 8 = 100 MHz
- R9- Resolution 9 = 1 GHz

MEASUREMENT FUNCTIONS

- FA- Fast Active (Ignore sample rate control)
- FP- Fast Passive (Terminates FA)
- RS- Reset Basic Counter and Converter. Take a new reading after reset.
- HA- Hold Active
- HP- Hold Passive

DATA MANIPULATION FUNCTIONS

- FO- Frequency Offset. Take a new reading after data entry if counter not in hold.
- PO- Power Offset. Take a new reading after data entry if counter not in hold.
- OA*- Offset Active:
 - Add Frequency Offset to Frequency Reading
 - Add Power Offset to Power Reading if Power Meter Function is active
- OP- Offset Passive (Terminates OA)
- ML- Multiplier. Multiplies frequency readings by an integer number.

* In Start-up Condition, although OA is Active, Frequency and Power Offsets are programmed to zero.

POWER METER

- PA- Power Meter Option Active. Initiate a new gate.
- PP- Power Meter Option Passive (Terminates PA)



FREQUENCY LIMITS

FH- Frequency Limit High. Basic counter and converter will be reset after data entry.

FL- Frequency Limit Low. Basic counter and converter will be reset after data entry.

SELF-TEST FUNCTION

TA- Test Active

TP- Test Passive (clear test function)

DATA FORMAT

EZ- Exponent Zero

ES- Exponent Scientific

DATA OUTPUT

BR- Output both frequency and power readings

FR- Output frequency readings only

PR- Output power readings only

SERVICE REQUEST

SR- Service request enable

DAC OPTION

DC- Select DAC option

DESCRIPTION OF AVAILABLE COMMANDS

DISPLAY

DA- Display Active - Outputs readings to both front panel and GPIB bus.

DP- Display Passive - Outputs readings to GPIB bus only. It will decrease the cycle time of the counter.

DN- Display Normal - Resets display only; used for clearing error messages on the display. Cannot be used after verifying preprogrammed data such as Frequency Offsets or Frequency Limits. This command affects only the display.

BAND

- B1- Selects Band 1
- B2- Selects Band 2.
- B3- Selects Band 3.
- B41- Selects Band 41. See Option 06.
- B42- Selects Band 42. See Option 06.
- B43- Selects Band 43. See Option 06.
- B44- Selects Band 44. See Option 06.

RESOLUTION

R.1 thru

R9- Resolution .1 thru 9 - Picks the front panel resolution from .1 Hz to 1 GHz. Also chooses gate time which is related to resolution: .1 Hz = 10 sec, 1 Hz = 1 sec, 10 Hz = 100 msec, 100 Hz = 10 msec and 1 kHz to 1 GHz = 1 msec.

MEASUREMENT FUNCTIONS

FA- Fast Active - Causes the counter to go into the fast cycle mode of operation. In this mode, the front panel sample rate/hold control is inactive and the fastest sample rate is attained. The counter will not go into the Fast Active mode of operation if Hold Active is enabled.

FP- Fast Passive - Terminates FA.

RS- Reset Basic Counter and Converter - Reacquires input signal and takes a new reading. Has the same function as manual reset button.

HA- Hold Active - The counter stops taking readings and the last frequency and power readings are displayed and held. The counter can be directed to take one reading when it is in this mode by sending Device Trigger or Selected Device Trigger GPIB bus command to the counter. It will also update the reading if the RS mnemonic is received.

HP- Hold Passive - Terminates HA.

DATA MANIPULATION FUNCTIONS

FO- Frequency Offset - Enables entry of frequency offsets. (1 Hz resolution available.) A new gate will be initiated after data entry if counter is not in HOLD.

PO- Power Offset - (See Option 02).

OA- Offset Active - Adds frequency offset to frequency readings. Adds power offset to power readings if power meter function is active.



OP- Offset Passive - Does not add frequency and power offset to readings.

ML- Multiplier - Enables entry of a 2-digit frequency readings multiplier. The multiplier must be an integer between 00 and 99. The results are to 1 kHz resolution. A new reading will be initiated after the data entry if the counter is not in HOLD. If the results of the multiplications are larger than or equal to 999.999,999,000 GHz, the counter will output 999.999,999,000 GHz to the bus if asked to output readings.

POWER METER

PA- Power Active (See Option 02).

PP- Power Passive (See Option 02).

FREQUENCY LIMITS

FH- Frequency Limit High - Enables entry of frequency limit high (10 MHz resolution available). The basic counter and converter will be reset after the data entry.

FL- Frequency Limit Low - Enables entry of frequency limit low (10 MHz resolution available). The basic counter and converter will be reset after the data entry.

SELF-TEST FUNCTIONS

TA- Test Active - Enables the counter to perform the selected test function by entering TA followed by two digits. When Test 05, 08, 09, or 10 is active and the counter is being asked to output data, the data that is displayed on the front panel is the data being output.

The output data format is as follows:

```
XXXXXXXXXXXXCRLF  
X      = alpha-numeric  
CR     = carriage return  
LF     = line feed
```

For detailed descriptions of tests 01 through 09 and test 11, see the section on Keyboard Controlled Circuit Tests.

TP- Test Passive - Terminates test function.

DATA FORMAT

EZ- Exponent Zero - output format.

ES- Exponent Scientific - output format.

DATA OUTPUT

BR- Outputs both frequency and power readings. (See section on output data format.)

FR- Outputs frequency readings only. (See section on output data format.)

PR- Outputs power readings only. (See section on output data format.)

DAC OPTION

DC- Enables the DAC option. Enter DC followed by two decimal digits which correspond to the location of the most significant digit in the three digits desired. To turn the DAC option off, input DC00 or DCP.

DC00 - turns DAC option off

DC02 - selects 1 Hz digit

thru

DC12 - selects 100, 10, and 1 GHz digits

SERVICE REQUEST

SR- Service Request Enable - Enables the counter to send Service Request to the bus when a certain event has taken place in the counter. To enable the function, input SR followed by two decimal digits. The two digits are the decimal equivalent of the content of the eight bit status register. More than one bit of the status register can be set.

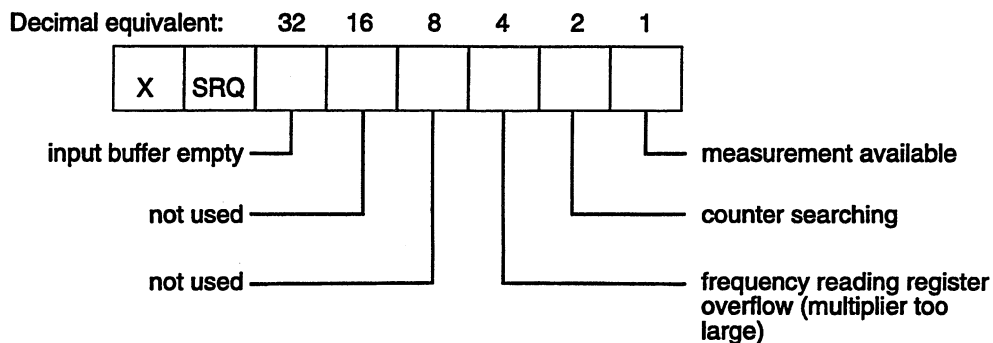

To disable the Service Request function, input SR00.

NOTE

Even when the Service Request function is disabled, the Service Request status byte will still be continuously altered to reflect the internal states of the counter.

SERVICE REQUEST MASK

The counter can be instructed to send an interrupt, by setting the SRQ line on the GPIB, when any ORed combination of the bits in the status byte are set. This is done by sending the counter a service request mask.

For example, to instruct the counter to generate an SRQ on measurement available OR input buffer empty, send the following service request mask:

OUTPUT 719;"SR33"



This would tell the counter to generate an SRQ whenever bit-0 or bit-5 of the status byte are set. Since bit-0 corresponds to measurement available and bit-5 corresponds to input buffer empty, the counter would generate an SRQ whenever either the input buffer was empty or a measurement was available.

The following items should be included in any program using the SRQ feature:

1. Tell the counter when to generate an SRQ. That is, tell the counter which events should generate an SRQ. This is done using the SRQMASK command.
2. Tell the controller to monitor the SRQ line on the GPIB. The SRQ is a maskable interrupt and the controller needs to know if it should respond to the interrupt.
3. Tell the controller what to do when it receives an SRQ interrupt.
4. Serial Poll the counter after an SRQ is generated to clear the interrupt. When the counter generates a SRQ it sets bit-6 in the status byte. Serial polling the instrument clears the SRQ bit and allows the instrument to generate a new SRQ upon the next occurrence of the conditions specified in the SRQ Mask.
5. It may also be necessary to clear the SRQ register in the controller. Consult your manual on the controller for more information on clearing the SRQ register in the controller.

The following program, written on a HP-9826, demonstrates how to use the SRQ feature to obtain a valid measurement from the counter.

```
10  ASSIGN @COUNTER TO 719      ! Assigns 719 to address variable
                                ! The number 7 is the GPIB interface
                                ! and 19 is the counters GPIB address
20  REMOTE @COUNTER              ! Place counter in Remote
30  OUTPUT @COUNTER;"SR01"      ! Send SRQ mask to counter
40  ENABLE INTR 7;2             ! Enable interrupt in controller
50  ON INTER 7 GOTO FLAG        ! Tell controller how to handle interrupt
60  PRINT "WAITING FOR VALID MEASUREMENT"  ! Label
70  WAITING:
80  GOTO WAITING
90  FLAG: PRINT "***** SRQ RECEIVED *****"
100 ENTER @COUNTER;FREQ         ! Input Frequency from counter
110 PRINT "FREQ" = ";FREQ"      ! Print Frequency
120 S2 = SPOLL(@COUNTER)        ! Clear SRQ bit in counter
130 STATUS 7,4;S               ! Clear SRQ bit in controller
140 OUTPUT @COUNTER;"SR00"      ! Turn off SRQ mask in counter
150 OFF INTR 7                  ! Turn off interrupt in controller
160  END                        ! Program end
```

To demonstrate this program, set up counter with no signal applied and start the program running. The controller should continually print out "Waiting for measurement." Then apply a signal. As soon as the counter finds the signal and counts it, the controller will print out the frequency of the signal.

DATA OUTPUT FORMAT

To output measurement results, the 545B/548B transmits the following string of characters:

Position	1	2	3	4	5	6	7	8	9	10	11	12	13	14	15	16	17	18
Format																		
EZ (Exponent Zero)	␣	±	D	D	D	D	D	D	D	D	D	D	D	D	E	0	CR	LF
ES (Exponent SCI)*	±	D	D	D	D	D	D	D	D	D	D	D	D	D	E	D	CR	LF
Power**	␣	␣	␣	␣	␣	␣	␣	␣	␣	±	D	D	D	.	D	CR	LF	

Freq. + Power

- FREQ in EZ mode: ␣ ± D D D D D D D D D D D D D D E 0, ␣ ␣ ␣ ␣ ␣ ␣ ␣ ␣ ␣ ± D D D . D CR LF
- FREQ in ES mode: ± D D D D D D D D D D D D D D E D, ␣ ␣ ␣ ␣ ␣ ␣ ␣ ␣ ␣ ± D D D . D CR LF

When the counter is in Test 05, 08, 09, or 10, the output will reflect the data on the display. The format is as follows:

```
XXXXXXXXXXXXCRLF.
␣ = Blank
D = Digit
X = Alpha-numeric Character
CR = Carriage Return
LF = Line Feed
```

* In Exponent Scientific one digit represents the position of the decimal point. Exponent digit can be either 0, 3, 6, or 9.

** For power data, the output resolution is fixed at 0.1 dB.

Under different output modes, the following counter outputs can be expected by a listener.

Output Mode	Counter Operating Mode	Output
BR	PA PP TA01	FREQ = PWR FREQ FREQ
FR	PA PP TA01	FREQ FREQ FREQ
PR	PA PP TA01	PWR -999.9 -999.9
BR, FR or PR	TA05, 08, 09, or 10	Data on front panel display



PROGRAM EXAMPLE

The following measurement conditions are set by addressing the counter to listen and then sending the following character string:

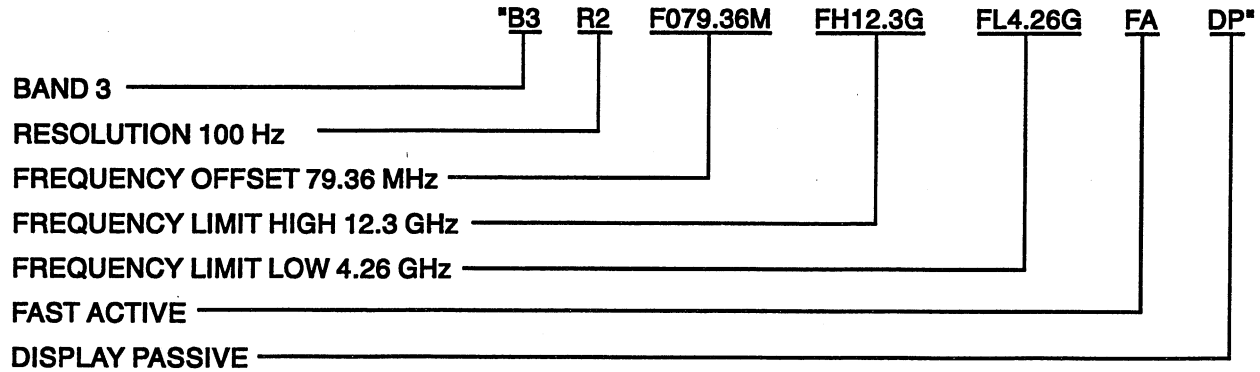

READING A MEASUREMENT

To read a measurement from the counter to a controller, the counter must first be addressed to talk and the controller to listen. The EIP counters use two different modes. The HOLD ACTIVE or HA mode takes one reading and then waits for a RESET command or a device trigger GPIB Command. In this condition the counter is sent a RESET or device trigger and (when addressed to talk) a new reading is output to the bus. The counter will hold that particular reading on the display until another RESET command or device trigger command is received. The second mode is HP or HOLD PASSIVE. In this mode, data is read out in a normal bus fashion. The display is automatically updated according to the sample rate chosen. In this condition, successive readings can be output without generating a RESET or device trigger command each time.

INPUT SPEED

It takes a specific amount of time for the counter to process the input data (error checking, formatting, changing the mode of operation, etc.). To prevent the data rate of the bus from slowing down while the counter is processing input data, the data is accepted as soon as it is available on the bus and is temporarily stored in memory. The size of the storage memory is 100 characters.

The users of the GPIB interface need to be aware of the difference between accepting data and complying with it. If the counter is asked to output a reading before it has finished processing the input data, the output will be in error if the operator makes the assumption that the counter is in the mode that was just programmed. To prevent this, sufficient programmed delays must be provided, or use must be made of the counter's Service Request status byte. See Service Request (SR) command description.

5

OPERATIONAL VERIFICATION TESTS

INTRODUCTION

This section contains test procedures that are used for verifying proper operation of the counter. Although these tests are not comprehensive, they do insure, to a high degree of confidence, that the instrument is operating properly. The tests can be useful for incoming inspection and should be performed after any servicing to insure proper operation of the counter. All tests can be performed without removing the instrument covers. A test report form that can be used to provide a test record is included at the end of this section. If the test application is especially critical in nature, more extensive testing of the counter may be required. See the performance verification test section in the service manual. Because of the high cost and specialized nature of frequency sources above 40 GHz, testing above this frequency is not covered. Also, for the purpose of operational verification tests, simulated pulsed signals are used in Bands 1 and 3.

EQUIPMENT REQUIREMENTS

Equipment required for the operational verification tests on the EIP 545B or 548B counter is listed in Table 5-1. The critical parameters are the minimum use specifications required for the performance of the procedures, and are included to assist in the selection of alternative equipment. Satisfactory performance of alternative items should be verified prior to use. All applicable equipment must bear evidence of current calibration. For some of the following tests, an EIP 548B counter is used to source lock the microwave sweeper, thus providing a stable source for testing. This combination may be replaced by a frequency synthesizer.



Table 5-1. Equipment Requirements.

Description	Critical Parameters	Recommended Manufacturer	Model
Synthesized Function Generator	10 Hz to 10 MHz	Wavetek	23
Sweep Generator	10 MHz to 26.5 GHz (40 GHz for Option 06)	Wiltron	6668A
Sweep Generator	3 GHz to 18 GHz	Wiltron	6635A
Source Locking Counter	10 MHz to 26.5 GHz	EIP	578B
Spectrum Analyzer	3 GHz to 18 GHz	Hewlett Packard	8566A
Power Meter	10 MHz to 60 GHz	Hewlett Packard	437B
Power Sensor	10 MHz to 18 GHz (-20 to +10 dBm)	Hewlett Packard	8481A
Power Sensor	100 MHz to 26.5 GHz (-25 to +20 dBm)	Hewlett Packard	8485A
Power Sensor	26.5 GHz to 40 GHz (-25 to +20 dBm)	Hewlett Packard	R8486A
Oscilloscope	DC to 100 MHz	Tektronix	475
Power Splitter	10 MHz to 26.5 GHz	Hewlett Packard	11667B
Directional Coupler	950 MHz to 18 GHz	Narda	4222-16
Directional Coupler	18 GHz to 26.5 GHz	Narda	4017B-10
Remote Sensor	26.5 GHz to 40 GHz	EIP	091
50 Ohm Termination		Pamona	4119-50

SOURCE LOCKING SETUP

In some of the following tests, the EIP 578B counter is used to source lock the sweep generator to provide a stable frequency source for testing the 545B/548B counters.

The source locking setup, described below, is not limited to locking the Wiltron sweeper. It can be used to source lock almost any electronically tunable signal source over a frequency range of 10 MHz to 110 GHz. For more information on source locking the Wiltron 6600 series of sweep generators, request Application Bulletin 10 from our sales representative in your area or directly from EIP.

Regardless of the particular sweeper, the procedure for source locking is basically the same. A sample of the output from the sweeper is applied to the appropriate band on the EIP 578B counter. For the setup shown in Figure 5-1, a power splitter provides the sample. The COARSE TUNE OUT connector from the 578B counter is connected to the external sweep input on the sweeper. The \emptyset LOCK OUT connector on the 578B counter is connected to the FM input on the sweeper. The FM modulation on the sweeper is enabled and the sweeper is set to the external sweep mode.

With the equipment set up as described above, source locking over the entire range of the sweeper can be achieved by entering the desired frequency.

For example, to lock the sweeper at 10 GHz:

PRESS:

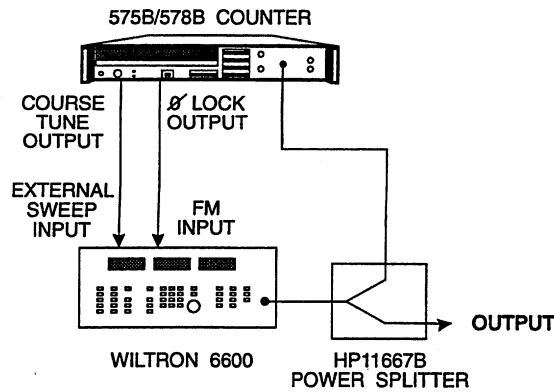

Figure 5-1. Source Locking Setup.

At this point, the sweeper should be locked to 10 GHz, the LCK annunciator on the counter should be lit, and 10 GHz should be the displayed frequency. In the following tests, the output frequency from the sweeper is controlled directly by the EIP 578B counter, while the power is controlled at the sweeper.

OPERATIONAL VERIFICATION TEST PROCEDURES

BAND 1 RANGE AND SENSITIVITY TEST (10 Hz to 10 MHz)

Description

This test verifies counter operation from 10 Hz to 10 MHz at 25 mVrms (70.7 mV p-p into 50 Ω). The oscilloscope is used to set signal levels.

Equipment

Synthesized Function Generator (Wavetek 23)

Oscilloscope (Tektronix 475)

Test Setup 1

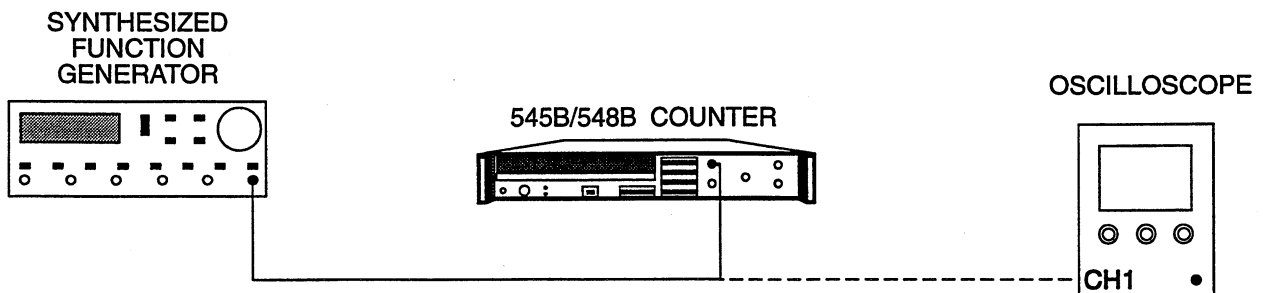

Figure 5-2. Band 1 Range and Sensitivity Test Setup (10 Hz to 10 MHz).

Procedure

1. Connect equipment as shown in Figure 5-2.
2. Set the counter to Band 1 and select resolution 2.
3. Set the output frequency from the synthesizer to 10 Hz.
4. Using the oscilloscope, set the output signal level from the synthesizer to 25 mV_{rms} (70.7 mV p-p into 50 Ω).
5. Apply the 10 Hz signal to the counter, verify proper reading, and record the results.
6. Repeat steps 3, 4, and 5 at 100 Hz, 1 kHz, 10 kHz, 100 kHz, 1 MHz, and 10 MHz.

BAND 1 - RANGE AND SENSITIVITY TEST (20 MHz to 100 MHz)

Description

This test verifies counter operation from 20 MHz to 100 MHz at 25 mV_{rms} (70.7 mV p-p into 50 Ω). The oscilloscope is used to set signal levels.

Equipment

Sweep Generator (Wiltron 6668A)
Source Locking Counter (EIP 578B)
Power Splitter (Hewlett Packard 11667B)
Oscilloscope (Tektronix 475)
50 Ω Termination (Pamona 4119-50)

Test Setup 2

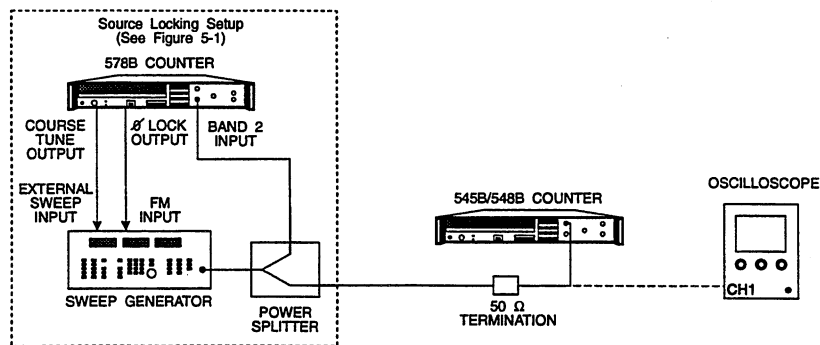

Figure 5-3. Band 1 Range and Sensitivity Test Setup (20 MHz to 100 MHz).

Procedure

1. Connect equipment as shown in Figure 5-3.
2. Set the 545B/548B counter to Band 1 and select resolution 3.

3. Using the EIP 578B counter, source lock the sweeper at 20 MHz.
4. Using the oscilloscope, set the output signal level from the synthesizer to 25 mV_{rms} (70.7 mV p-p into 50 Ω).
5. Apply the 20 MHz signal to the 545B/548B counter, verify proper reading, and record the results.
6. Repeat steps 3, 4, and 5 at 50 and 100 MHz.

BAND 2 RANGE AND SENSITIVITY TEST

Description

This test verifies counter operation from 10 MHz to 1 GHz at -15 dBm. The power meter is used to set signal levels.

Equipment

Sweep Generator (Wiltron 6668A)
 Source Locking Counter (EIP 578B)
 Power Meter (Hewlett Packard 437B)
 Power Sensor (Hewlett Packard 8481A)
 Power Splitter (Hewlett Packard 11667B)

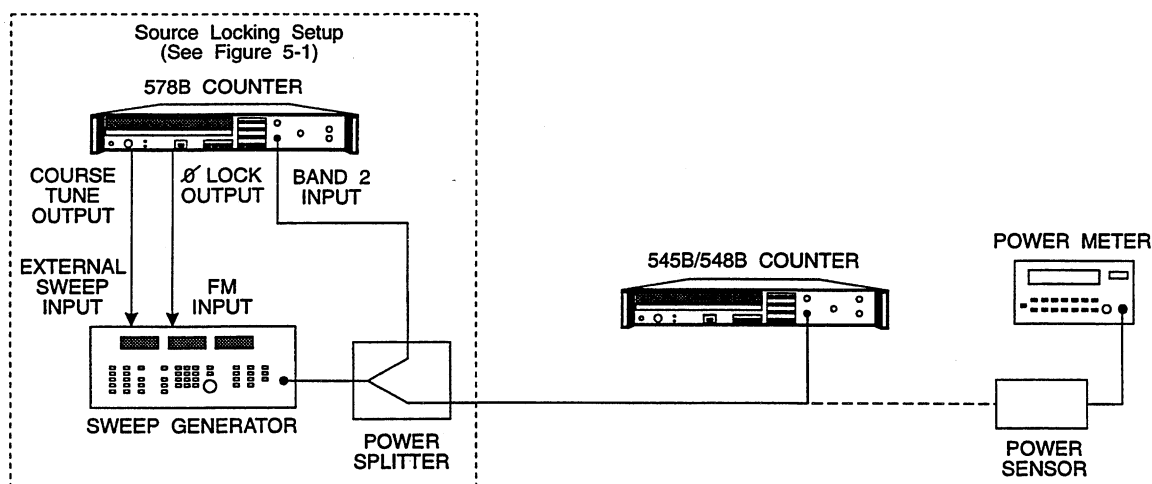

Figure 5-4. Band 2 Range and Sensitivity Test Setup.

Procedure

1. Connect equipment as shown in Figure 5-4.
2. Set the 545B/548B counter to Band 2 and select resolution 3.
3. Using the EIP 578B counter, source lock the sweeper at 10 MHz.

- Using the power meter, set the output signal level from the sweeper to -20 dBm.
- Apply the 10 MHz signal to the counter, verify proper reading, and record the results.
- Repeat steps 3, 4, and 5 at 100 MHz, 250 MHz, 300 MHz, 400 MHz, 500 MHz, 600 MHz, 700 MHz, 800 MHz, 900 MHz, and 1 GHz.

BAND 3 RANGE AND SENSITIVITY TEST

Description

This test verifies counter operation from 1 GHz to 20 GHz (26.5 GHz for the 548B counter).

Equipment

Sweep Generator (Wiltron 6668A)
Source Locking Counter (EIP 578B)
Power Meter (Hewlett Packard 437B)
Power Sensor (Hewlett Packard 8485B)
Power Splitter (Hewlett Packard 11667B)

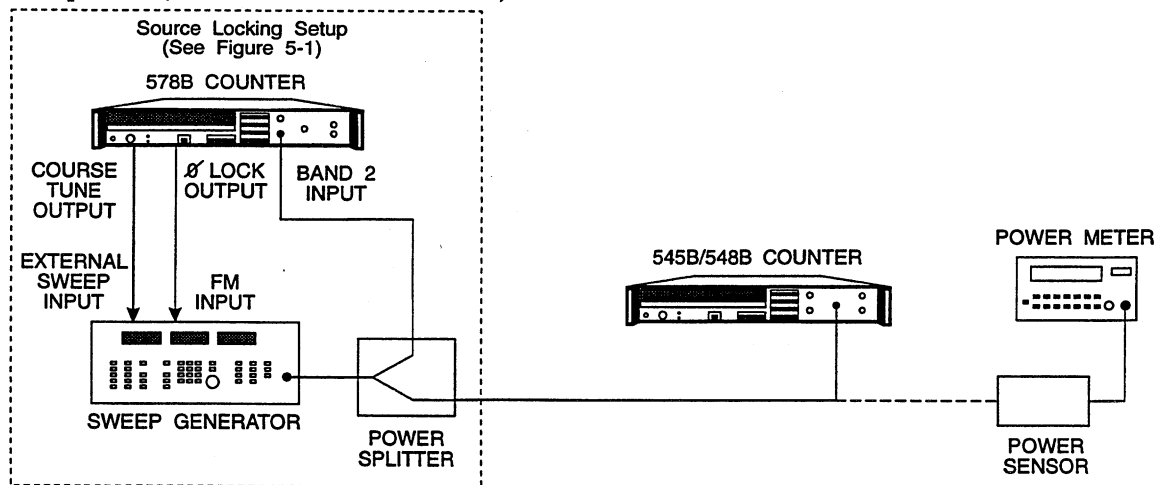

Figure 5-5. Band 3 Range and Sensitivity Test Setup.

Procedure

- Connect equipment as shown in Figure 5-5.
- Set the counter to Band 3 and select resolution 3.
- Using the EIP 578B counter, source lock the sweeper at 1 GHz.
- Using the power meter, set the output signal level from the sweeper to -30 dBm.
- Apply the 1 GHz signal to the 545B/548B counter, verify proper reading, and record the results.

6. Repeat steps 3, 4, and 5 at 3 GHz, 5 GHz, 10 GHz, and 12.4 GHz. Then, at a signal level of -25 dBm, test at 15 GHz, 18 GHz, and 20 GHz. For Model 548B counters only: At a signal level of -20 dBm, test also at 22 GHz, 24 GHz, and 26.5 GHz.

BAND 3 AMPLITUDE DISCRIMINATION TEST

Description

This test verifies that the counter will measure accurately the larger of two signals differing in amplitude by 10 dB or more.

Equipment

Sweep Generator (Wiltron 6635A)
 Sweep Generator (Wiltron 6668A)
 Spectrum Analyzer (Hewlett Packard 8566A)
 Power Splitter (Hewlett Packard 11667B)

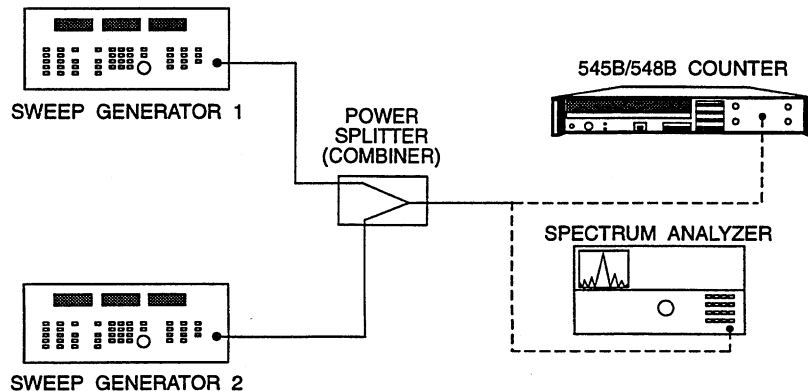

Figure 5-6. Band 3 Amplitude Discrimination Test Setup.

Procedure

1. Connect equipment as shown in Figure 5-6.
2. Set signal generator 1 to 3.0 GHz at 0 dBm and set signal generator 2 to 3.1 GHz at +6 dBm.
3. Using the spectrum analyzer, adjust the generator power levels so that the signal amplitude difference is 10 dB.
4. Verify that the counter correctly measures the frequency of the higher power signal source.
5. Repeat steps 2, 3, and 4 at 6 and 6.1 GHz, at 12 and 12.1 GHz, and at 17.9 and 18 GHz.

**BAND 4, SUBBAND 1 RANGE AND SENSITIVITY TEST (548B Option 06 Only)****Description**

This test verifies counter operation from 26.5 GHz to 40 GHz at -25 dBm.

Equipment

Sweep Generator (Wiltron 6668A)
Power Meter (Hewlett Packard 437B)
Power Sensor (Hewlett Packard R8486A)
Remote Sensor (EIP 091)
Cable Kit (EIP 590)

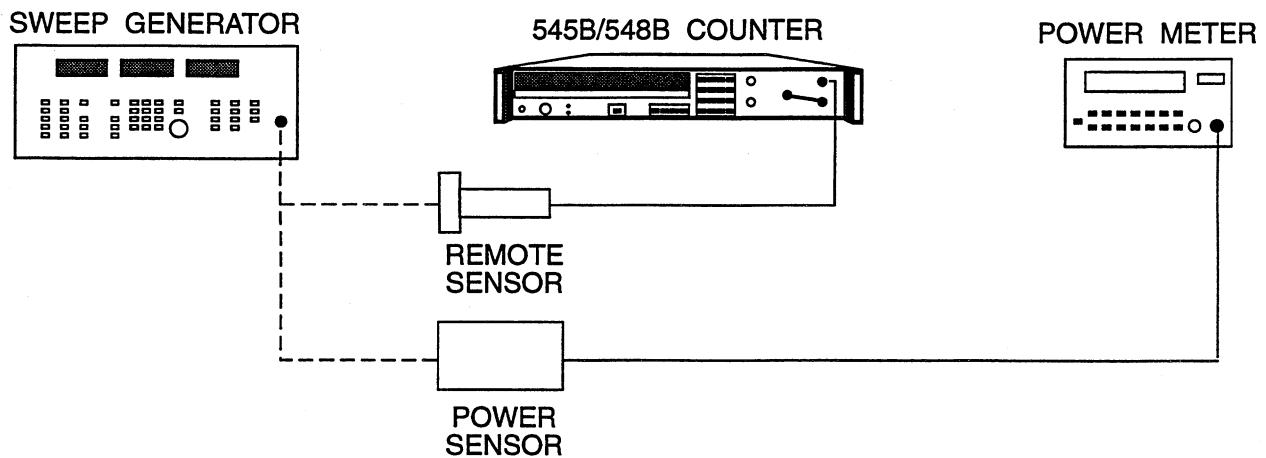

Figure 5-7. Band 4 Range and Sensitivity Test Setup (Model 548B, Option 06).

Procedure

1. Connect equipment as shown in Figure 5-7.
2. Set the counter to Band 4 and select resolution 3.
3. Set the output frequency from the sweeper to 26.5 GHz.
4. Using the power meter, set the output signal level from the sweeper to -25 dBm.
5. Apply the 26.5 GHz signal to the remote sensor, verify proper reading, and record the results.
6. Repeat steps 3, 4, and 5 at 30, 35, and 40 GHz.

OPERATIONAL TEST RECORD

MODEL _____	SERIAL NO. _____	DATE _____
TEST	ACTUAL	SPECIFICATIONS
BAND 1 RANGE AND SENSITIVITY TEST		10 Hz to 100 MHz
INPUT SENSITIVITY	10 Hz _____	25 mVrms
	100 Hz _____	
	1 kHz _____	
	10 kHz _____	
	100 kHz _____	
	1 MHz _____	
	10 MHz _____	
	20 MHz _____	
	50 MHz _____	
	100 MHz _____	
BAND 2 RANGE AND SENSITIVITY TEST		250 MHz to 1 GHz
INPUT SENSITIVITY	10 MHz _____	-20 dBm
	100 MHz _____	
	250 MHz _____	
	300 MHz _____	
	400 MHz _____	
	500 MHz _____	
	600 MHz _____	
	700 MHz _____	
	800 MHz _____	
	900 MHz _____	
	1 GHz _____	
BAND 3 RANGE AND SENSITIVITY		1 GHz to 20 GHz (26.5 GHz)
INPUT SENSITIVITY	1 GHz _____	-30 dBm
	3 GHz _____	
	6 GHz _____	
	10 GHz _____	
	12.4 GHz _____	
	15 GHz _____	-25 dBm
	18 GHz _____	
	20 GHz _____	
548B ONLY	22 GHz _____	-20 dBm
	24 GHz _____	
	26.5 GHz _____	



OPERATIONAL TEST RECORD (Continued)

TEST	ACTUAL	SPECIFICATIONS
BAND 3 AMPLITUDE DISCRIMINATION TEST		
CONDITIONS: F1 > F2 BY 15 dB OR MORE		
F1	F2	
3 GHz	3.1 GHz _____	10 dB
6.1 GHz	6 GHz _____	
12 GHz	12.1 GHz _____	
18 GHz	17.9 GHz _____	
BAND 4-1 RANGE AND SENSITIVITY TEST		26.5 GHz to 40 GHz
(548B, OPTION 06)		
INPUT SENSITIVITY	26.5 GHz _____	-25 dBm (typical)
	30 GHz _____	
	35 GHz _____	
	40 GHz _____	